

PRODUCT

CATALOG



QUALITY LAB ACCESSORIES

YOUR DISSOLUTION SPECIALISTS



ABOUT US

Quality Lab Accessories, LLC (QLA) is a leading manufacturer and supplier of Dissolution Accessories and Consumables, Calibration Tools and Services to Pharmaceutical Laboratories, worldwide. We pride ourselves on being the only company in our industry that not only has a dedicated sales force but also a fully staffed machine shop and modern manufacturing facility located in Telford, PA. Our products are engineered and manufactured according to the precise specifications of the USP and Original Equipment Manufacturer (OEM). QLA is the "go-to" company for custom fabrication. We solve unique lab problems with innovative designs and common sense solutions.

QLA operates a Quality Management System which complies with the requirements of the ISO 9001 current standard (certificate# FM595556). Our Lab Services division is ISO/IEC 17025 accredited (certificate# L15-277).

In addition to our commitment to ISO, we are also fully committed to all applicable regulatory standards, including:

- U.S. Pharmacopeia General Chapters 701, 711, 724, 1092 and others,
- ASTM E2503 Standard Practice for Qualification of Basket and Paddle Dissolution Apparatus,
- Calibration tools and services are traceable to N.I.S.T. standards.

Our customers know that help from QLA is just a phone call or email away. We have a large inventory of items in stock and ready to ship within 24 hours. Throughout the world, our customers' needs have been met for over 20 years with unsurpassed customer service and the highest quality products available. QLA's main goal is to give our customers the ultimate customer experience in our industry!

OUR QUALITY POLICY

Quality Lab Accessories, LLC is committed to exceeding our customer's expectations through unparalleled customer service, continual quality improvement, equitable pricing and on-time delivery.

Quality Lab Accessories, LLC will strive to add customer value by continually reaching for excellence in all facets of our company's operation through ongoing reviews of current methods in order to improve our processes and products.

QLA is
ISO 9001
registered.
Certificate#
FM595556.



QLA Lab Services
Division is
ISO/IEC 17025
accredited.
Certificate# L15-277.



PJLA
Calibration
Accreditation# 83857

MANUFACTURER (OEM) REFERENCES

Equivalent manufacturer product part numbers appear in the "OEM Ref" column of product listings.

An OEM Reference located within a product listing that is not attributed to a specific manufacturer will have the relevant manufacturer's initial icon adjacent to it.

When "QLA" appears in the OEM Ref column, it signifies a QLA innovated product designed for use in that manufacturer's dissolution application or universal products which can be used in all dissolution applications.



All QLA dissolution accessories and consumables have been manufactured in the USA and are U.S. Pharmacopeia compliant where applicable and meet machine manufacturer's specifications. Information including QLA part numbers, descriptions, OEM part numbers and specifications in this publication are subject to change without notice.



TABLE OF CONTENTS

BASKETS: APP 1	4
BASKET SHAFTS: APP 1	9
PADDLES: APP 2	11
SPIN SHAFT ACCESSORIES: APP 1 & APP 2	13
CAPSULE SINKERS	16
VESSELS	20
VESSEL COVERS	26
SAMPLING CANNULA	28
CANNULA FILTERS	34
TRANSDERMAL TESTING: APP 5 & APP 6	38
BIODISSOLUTION ACCESSORIES: APP 3	40
CALIBRATION TOOLS	41
MISC DISSOLUTION ACCESSORIES	43
GLASS ACCESSORIES	46
DISINTEGRATION TESTING	47

BASKETS

THE BASKET METHOD Apparatus 1

Adopted in 1970, the rotating basket method of dissolution testing was the first official method. It essentially consists of an approximately 1 inch (25.4mm) x 1 3/8 inch (34.925mm) stainless steel, 40 mesh wire basket rotated at a constant speed between 25 and 150rpm. This method is now called Apparatus 1 (or Method 1).

The apparatus consists of a metallic drive shaft connected to the cylindrical basket. The basket is positioned inside a vessel made of glass or other inert, transparent material (see page 20). The vessel contents are kept at a constant temperature by being placed inside a water bath or heating jacket. The solution in the vessel is stirred smoothly by the rotating basket.

The USP Method 1 requires a 40 mesh screen unless otherwise specified in the monograph. Other meshes can be used to solve individual problems.

Baskets and basket shafts should be serialized where possible and the serial number noted for each test. All baskets are supplied with a Certificate of Conformance (COC) stating that they are USP compliant, where applicable, and that they meet the machine manufacturer specifications. A Certificate of Analysis (COA) is available at an additional cost.

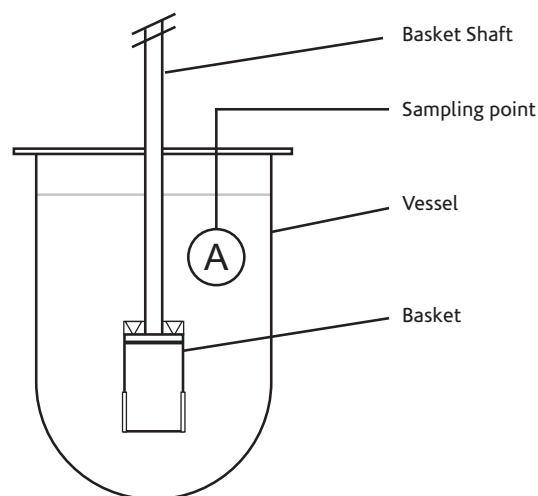

KEY CONSIDERATIONS

Mesh Openings — One of the biggest problems associated with the basket method involves the clogging of the mesh openings by particles or excipients or the random release of particles through the mesh to the bottom of the vessel. Baskets with a wide variety of mesh openings are available and if the disaggregated particle size is consistent, a variation of mesh size may solve some difficult dissolution problems.

Sintered Mesh — Every QLA stainless steel basket, that conforms to USP, is manufactured using a sintered mesh. Sintering is a strengthening process that compresses and heats the mesh under high pressures and temperatures. This results in welded joints at all the wire overlaps and adds considerable strength and longevity to the basket.

Suppository Baskets — Made from plastic, these baskets have vertical slots instead of mesh to facilitate dissolution. Blocking and/or clogging of the mesh opening is prevented by the use of such a basket, particularly when oil-based suppositories are used.

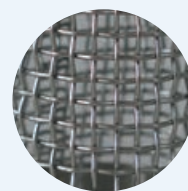

10 MESH

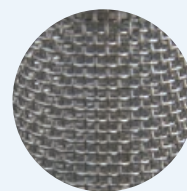

20 MESH

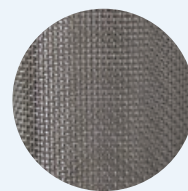

40 MESH



SUPPOSITORY BASKETS

Note: Other mesh sizes are available on request. For more information, contact your QLA Sales Rep.

CARE & MAINTENANCE

Basket Handling — Since dissolution basket mesh is easily deformed, baskets should only be handled by the upper rim. QLA offers a special tool for installation and removal of baskets from the basket shaft (see page 6).

Basket Cleaning — Care should be exercised to ensure that baskets are clean prior to use. Often the dosage form can clog the mesh which will prevent free media movement into the basket. Careful cleaning is required to ensure there is no contamination between tests.

Basket Storage — Baskets should be stored correctly to extend their life. They can frequently be found rolling around in a lab drawer! Baskets can easily be stored in the supplier's case or using a specially designed basket holder (see page 7).

Note: All baskets are laser marked with a unique serial number and come with COC (where applicable).



AGILENT COMPATIBLE BASKETS
(INCLUDES LEGACY VANKEL)

Part No.	Description	OEM Ref
BSK010-01	10 Mesh Basket, Clip Style, 316 SS, Serialized	12-2125
BSK020-01	20 Mesh Basket, Clip Style, 316 SS, Serialized	12-2120
BSK040-01	40 Mesh (USP) Basket, Clip Style, 316 SS, Serialized	12-2100
BSK100-01	100 Mesh Basket, Clip Style, 316 SS, Serialized	12-2154
BSKPTV-40	40 Mesh Basket, Clip Style, PTFE Coated over 316 SS	12-2110
BSKSUP-01	Suppository Basket, Plastic	12-2130



DISTEK COMPATIBLE BASKETS

Part No.	Description	OEM Ref
BSK010-DK	10 Mesh Basket, Standard Push-On Style, 316 SS, Serialized	2821-0160
BSK010-DKC	10 Mesh Basket, Evolution Style, 316 SS, Serialized	2800-0041
BSK020-DK	20 Mesh Basket, Standard Push-On Style, 316 SS, Serialized	2821-0159
BSK020-DKC	20 Mesh Basket, Evolution Style, 316 SS, Serialized	2800-0042
BSK040-DK	40 Mesh (USP) Basket, Standard Push-On Style, 316 SS, Serialized	2821-0072
BSK040-DKC	40 Mesh (USP) Basket, Evolution Style, 316 SS, Serialized	2800-0032
BSK100-DK	100 Mesh Basket, Standard Push-On Style, 316 SS, Serialized	2800-0004
BSK100-DKC	100 Mesh Basket, Evolution Style, 316 SS, Serialized	2800-0043
BSKPTD-40	40 Mesh Basket, Standard Push-On Style, PTFE Coated over 316 SS	QLA
BSKSUP-DK	Suppository Basket, Plastic	3250-0445
BSKHUB-DK	Basket Adapter Hub for Standard Push-On Style, 316 SS, Serialized	2821-1052
BSKHUB-DKC	Basket Adapter Hub for Evolution Style, 316 SS, Serialized	2821-0459
BSKCLP-DKC	Basket Clip for Evolution Style Hub, 316 SS	3100-0017



ERWEKA COMPATIBLE BASKETS

Part No.	Description	OEM Ref
BSK010-EW	10 Mesh Basket, Clip Style, 316 SS, Serialized	90-000-6010
BSK020-EW	20 Mesh Basket, Clip Style, 316 SS, Serialized	90-000-6020
BSK040-EW	40 Mesh (USP) Basket, Clip Style, 316 SS, Serialized	90-000-6040
BSKSUP-EW	Suppository Basket, Plastic	70-000-5004



HANSON COMPATIBLE BASKETS

Part No.	Description	OEM Ref
BSK010-HR	10 Mesh Basket, Clip Style, 316 SS, Serialized	65-220-010
BSK020-HR	20 Mesh Basket, Clip Style, 316 SS, Serialized	65-220-020
BSK040-HRP	40-Mesh (USP) Precision Basket, Clip Style, 316 SS, Serialized	74-105-252
BSK100-HR	100 Mesh Basket, Clip Style, 316 SS, Serialized	QLA
BSKPTH-40	40 Mesh Basket, Clip Style, PTFE Coated over 316 SS	QLA
BSKSUP-HR	Suppository Basket, Plastic	65-700-048



PHARMATEST COMPATIBLE BASKETS

Part No.	Description	OEM Ref
BSK010-PT	10 Mesh Basket, Clip Style, 316 SS, Serialized	311-2804
BSK020-PT	20 Mesh Basket, Clip Style, 316 SS, Serialized	QLA
BSK040-PT	40 Mesh (USP) Basket, Clip Style, 316 SS, Serialized	311-2803
BSKPTP-40	40 Mesh Basket, Clip Style, PTFE Coated over 316 SS	QLA
BSKSUP-PT	Suppository Basket, Plastic	QLA



SOTAX COMPATIBLE BASKETS

Part No.	Description	OEM Ref
BSK010-ST	10 Mesh Basket, Clip Style, 316 SS, Serialized	QLA
BSK020-ST	20 Mesh Basket, Clip Style, 316 SS, Serialized	QLA
BSK040-ST	40 Mesh (USP) Basket, Clip Style, 316 SS, Serialized	2830
BSKSUP-ST	Suppository Basket, Plastic	QLA



BASKET INSERTION AND REMOVAL TOOL

QLA's Basket Tool provides a firm grip on baskets without damage to the basket during insertion and removal from shafts. The tool grabs the lower rim and protects the delicate wire mesh for an easy fit of basket onto shaft.

Key Benefits:

- Can be used with any standard size dissolution basket
- Decreases contamination from hands
- Basket damage can result in excessive basket wobble and mechanical calibration failure
- Simple but effective design
- Can significantly increase the life of baskets and pay for itself in no time.

Part No.	Description	OEM Ref
BSKTOOL	Basket Insertion/Removal Tool	QLA
BSKTOOL-DK	Basket Insertion/Removal Tool for thick rim baskets	QLA



OVERSIZE 40 MESH 24.5MM ID BASKET AND BASKET SHAFTS

Part No.	Description	OEM Ref
CUSTBSK-40	40 Mesh Basket, Clip Style, 24.5mm ID, 316 SS, Serialized	QLA
CLIPHUB-DK	Detachable Basket Hub for 24.5mm Basket, 316 SS, Serialized (Distek compatible)	QLA
CUSTSHT-DK	16.5" (420mm) Basket Shaft for 24.5mm Basket, 316 SS, Serialized (Distek compatible)	QLA
CUSTSHT-EW20	20" (508mm) Basket Shaft for 24.5mm Basket, 316 SS, Serialized (Erweka compatible)	QLA
CUSTSHT-HR	16" Basket (405mm) shaft for 24.5mm Basket, 316 SS, Serialized (Hanson SR8-Plus compatible)	QLA
CUSTSHT-HRV	Basket Shaft for 24.5mm Basket, 316 SS, Serialized (Hanson Vision compatible)	QLA
CUSTSHT-VK15	15" (380mm) Basket Shaft for 24.5mm Basket, 316 SS, Serialized (VanKel/Varian compatible)	QLA
CUSTSHT-VK13	14.5" (370mm) Basket Shaft for 24.5mm Basket, 316 SS, Serialized (V-Series compatible)	QLA
CUSTSHT-VK19	19" (480mm) Basket Shaft for 24.5mm Basket, 316 SS, Serialized	QLA



CUSTBSK-40



BASKET SHAFT FOR 24.5MM BASKET

Note: Custom length shafts and other mesh sizes are available upon request.

METFORMIN SAMPLE HOLDERS

Part No.	Description	OEM Ref
VERTHLD-500	Vertical Sample Holder for Metformin 500mg, 316 SS	12-2170 ^A
VERTHLD-750-1K	Vertical Sample Holder for Metformin 750mg or 1000mg, 316 SS	12-2165 ^A

OEM Key
^A AGILENT

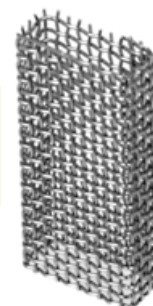

VERTHLD-500

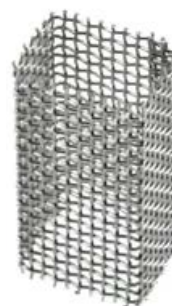

VERTHLD-750-1K

BASKET STORAGE

QLA's Basket Holders provide a convenient way to organize and store baskets when not in use. The chances of accidentally damaging baskets can be significantly reduced with the use of a good quality basket holder.

Key Benefits:

- Compatible with all popular basket types (Agilent, Distek, Erweka, Hanson, Pharmatest, Sotax)
- To ensure your tests meet USP requirements, it is essential that all baskets are not bent or deformed
- O-rings ensure baskets are held firmly to the holder
- Fully stackable to maximize storage space and transport many baskets
- Low cost — it pays for itself by preventing damage to just one basket!

Part No.	Description	OEM Ref
BSKHLD-6	6 Position Basket Holder	QLA
BSKHLD-12	12 Position Basket Holder	QLA



BSKHLD-6



BSKHLD-12

FELODIPINE BASKETS

Can be used on most dissolution testers.

The USP Monograph for Felodipine Extended-Release Tablets specifies the use of a quadrangular stationary basket. The QLA Stationary Basket fully complies with the USP Monograph.

The QLA Felodipine Basket is made from precision welded 316 stainless steel mesh and the basket is securely fixed to the shaft and will not easily bend or break off. The basket also features a small flap to prevent the tablet from escaping during testing. The flap is fabricated so that it will not fall off or be lost during use.

USP 26 requires the use of a basket suspended a precise distance from the paddle shaft, which in turn requires the use of a modified vessel cover.

Key Considerations:

- The Felodipine Basket method offers a potential solution to problems associated with floating, sticking and swelling dosage forms.
- While the use of sinkers may solve similar problems, their final position in the dissolution vessel may vary, thus contributing to variations in test results — these variations can be eliminated by using the stationary basket.
- Suitability for certain applications must be verified.

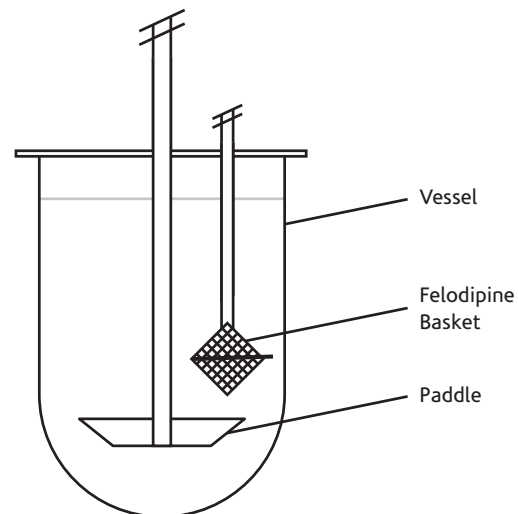

Part No.	Description	OEM Ref
STABSK-VK8	Felodipine Quadrangular Basket, 8 Mesh, 316 SS	QLA



STATIONARY BASKETS

Can be used on most dissolution testers. A modified vessel cover may be needed.

Part No.	Description	OEM Ref
STABSK-10	Stationary Basket Assembly with Basket Shaft and 10 Mesh Basket, 316 SS	12-2061 A
STABSK-20	Stationary Basket Assembly with Basket Shaft and 20 Mesh Basket, 316 SS	12-2060 A
STABSK-40	Stationary Basket Assembly with Basket Shaft and 40 Mesh Basket, 316 SS	12-2063 A

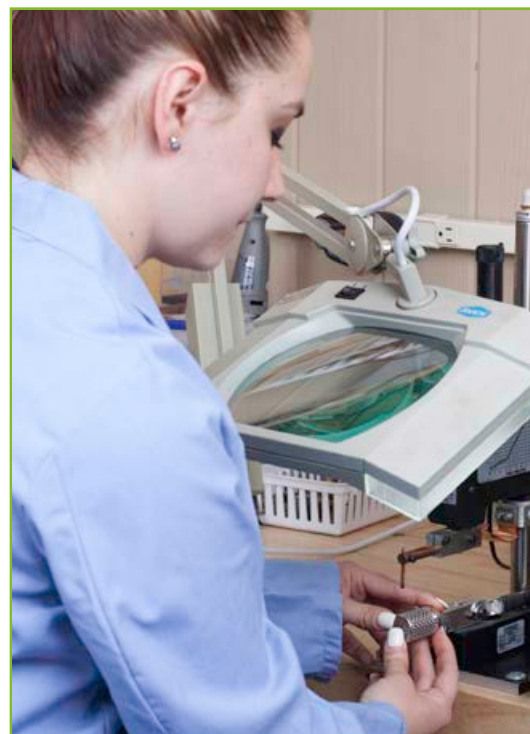

QLA is the Only On-site Basket Manufacturer in the Industry

All baskets made in our facility with a focus on precision and quality.

BASKET SHAFTS

THE BASKET SHAFT Apparatus 1

The basket shaft is the metallic drive shaft in Apparatus 1 which is connected to the cylindrical basket. See page 4 for more information on Apparatus 1. All shafts are constructed from type 316 electropolished stainless steel.

KEY CONSIDERATIONS

Clip or Clipless?

Spring Clips — The USP standard dissolution basket is designed to attach to the basket shaft using spring clips. Over time these clips can lose strength and fail to grip the basket securely. Baskets that are not gripped securely are likely to exhibit excessive wobble. Only QLA clips are made from special spring tempered 316 stainless steel. Competitors' clips are made from annealed 316 stainless steel. Spring tempered 316 stainless steel clips will maintain its gripping strength much longer than annealed 316 stainless steel clips.

O-Ring — The clipless basket fastens to the shaft using an O-ring instead of clips. While it can be argued that this design reduces wobble and is easier to use, the USP still specifies the use of clips and proof of equivalence may be required if a clipless alternative is to be used.



SPRING CLIP STYLE



O-RING STYLE

Note: All basket shafts are laser marked with a unique serial number and come with COC.

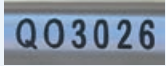

CARE & MAINTENANCE

Shaft Storage — Bent or scratched shafts fail to comply with USP regulations so it is essential not to store shafts on a desk or loose in a drawer where damage or corrosion can occur. Proper storage in a basket shaft/paddle holder can prevent damage from occurring. See page 11 for Basket Shaft/Paddle Holders.

Wobble — A Wobble Meter (WOBMET-MI) is available to monitor basket shaft wobble. See page 42 for Wobble Meter.

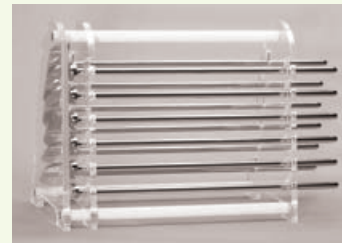

BASKET SHAFT/PADDLE HOLDER



WOBBLE METER

AGILENT COMPATIBLE BASKET SHAFTS

(INCLUDES LEGACY VANKEL)

Part No.	Description	OEM Ref
BSKSHT-13	14.5" (370mm) Basket Shaft for V-Series, Spring Clip Style, 316 SS, Serialized	13-3615
BSKSHT-15	15" (380mm) Basket Shaft, Spring Clip Style, 316 SS, Serialized	12-2070
BSKSHT-15C	15" (380mm) Conical Basket Shaft, Spring Clip Style, 316 SS, Serialized	12-2075
BSKSHT-15CO	15" (380mm) Conical Basket Shaft, Push-On Style, 316 SS, Serialized	12-2050
BSKSHT-19	19" (480mm) Basket Shaft, Spring Clip Style, 316 SS, Serialized	12-2080
BSKSHT-19C	19" (480mm) Conical Basket Shaft, Spring Clip Style, 316 SS, Serialized	12-2081
BSKSHT-19CO	19" (480mm) Conical Basket Shaft, Push-On Style, 316 SS, Serialized	12-2056
BSKSHT-21	21" (535mm) Basket Shaft, Spring Clip Style, 316 SS, Serialized	13-3620
BSKSHT-24	24" (610mm) Basket Shaft, Spring Clip Style, 316 SS, Serialized	13-3629



BSKSHT-13, BSKSHT-15, BSKSHT-19, BSKSHT-21, BSKSHT-24



BSKSHT-15C, BSKSHT-19C



BSKSHT-15CO, BSKSHT-19CO

DISTEK

COMPATIBLE BASKET SHAFTS

Part No.	Description	OEM Ref
BSDRNG-16	16.5" (420mm) Basket Shaft, Standard Push-On Style, 316 SS, Serialized	2821-0074
BSDRNG-19	19" (480mm) Basket Shaft, Standard Push-On Style, 316 SS, Serialized	QLA
BSKSHT-16.5	16.5" (420mm) Basket Shaft, Spring Clip Style, 316 SS, Serialized	QLA
SHFT16.5-DK	16.5" (420mm) Detachable Shaft, 316 SS, Serialized	2800-0165
SHFT21-DK	21" (535mm) Detachable Shaft, 316 SS, Serialized	2800-0334
SHFT21-NPD	21" (535mm) Detachable Shaft, PTFE coated over 316 SS, Serialized	2800-0334-T
BSKHUB-DK	Basket Adapter Hub for Standard Push-On Style, 316 SS, Serialized	2821-1052
BSKHUB-DKC	Basket Adapter Hub for Evolution Style, 316 SS, Serialized	2821-0459
BSKCLP-DKC	Basket Clip for Evolution Style, 316 SS	3100-0017
ORING-DK	Red Silicone O-Ring for Distek Basket Hubs (Pack/12)	5570-8007
ORING-SHFT	Black Viton O-Ring for Distek Detachable Shafts (Pack/12)	5570-8044
TUMSCR-DK	Shaft Collar with Thumb Screw for 2100 Series	2821-0094



BSDRNG-16, BSDRNG-19



SHFT16.5-DK, SHFT21-DK



BSKCLP-DKC

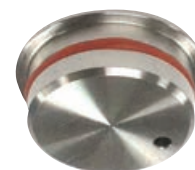

BSKHUB-DK



BSKHUB-DKC

ERWEKA

COMPATIBLE BASKET SHAFTS

Part No.	Description	OEM Ref
BSKSEW-15	15" (380mm) Basket Shaft with 10mm OD, Spring Clip Style, 316 SS, Serialized	QLA
BSKSEW-19	19" (480mm) Basket Shaft with 10mm OD, Spring Clip Style, 316 SS, Serialized	QLA



BSKSEW-15, BSKSEW-19

HANSON

(SR8-PLUS) COMPATIBLE BASKET SHAFTS

Part No.	Description	OEM Ref
BSKSHT-16	16" (405mm) Basket Shaft, Spring Clip Style, 316 SS, Serialized	65-237-000

Note: Hanson Vision 2-piece Shafts can be found in SPIN SHAFT Section, page 14.



BSKSHT-16

SOTAX

COMPATIBLE BASKETS

Part No.	Description	OEM Ref
BSKSHT-ST	Basket Shaft with 10mm OD, Spring Clip Style, 316 SS, Serialized	QLA



BSKSHT-ST

Don't see what you're looking for in this catalog?

QLA continually adds new products and has the largest inventory of dissolution accessories available. Most items are in stock and ship within 24 hrs!

Be sure to check out our website at www.QLA-LLC.com

PADDLES

THE PADDLE METHOD Apparatus 2

Apparatus 2, commonly known as the paddle method, has similar physical specifications to those of Apparatus 1 with a paddle substituted for the rotating basket.

Some of the dimensions and tolerances for the paddle are critical if consistent results are to be obtained from vessel to vessel.

The USP specifies that the paddle must rotate smoothly without significant wobble. The arc of the paddle blade creates considerable flow and any wobble will have an exaggerated effect on the flow profile.

The contours of the paddle blade must not include any sharp edges — at the tips for instance — that could produce turbulent instead of laminar flow patterns.

All QLA paddles are certified U.S. Pharmacopeia compliant where applicable and meet machine manufacturer specifications.

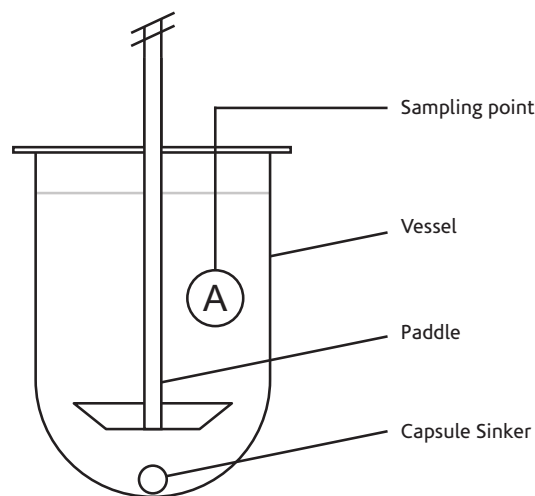

KEY CONSIDERATIONS

Types of Paddles:

Electropolished 316 Stainless Steel — The 316 stainless steel (316 SS) shaft is strong and has a high resistance to bending. It is electropolished for removal of surface impurities and corrosion resistance.

PTFE Coated — The USP suggests that paddles may be coated with an inert coating. Most paddles are accordingly coated with PTFE or another inert coating. If peeling or flaking of the coating is observed then the paddles should be replaced.

Solid Fluoropolymer — The single piece molded design features a fluoropolymer blade and single piece stem molded onto an electropolished 316 SS shaft.

This innovative design features no paddle-to-shaft joint, thus eliminating potential cross-contamination and removing a probable corrosion path. Wobble is also considerably reduced in the solid fluoropolymer paddle because it is a single piece cast.

CARE & MAINTENANCE

Shaft Storage — Bent or scratched shafts fail to comply with USP regulations so it is essential not to store shafts on a desk or loose in a drawer where damage or corrosion can occur. Proper storage in a basket shaft/paddle holder can prevent damage from occurring. See below for Basket Shaft/Paddle Holders.

Wobble — A Wobble Meter (WOBMET-MI) is available to monitor paddle wobble. See page 42 for Wobble Meter.



Note: All paddles are laser marked with a unique serial number and come with COC.

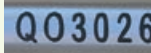

BASKET SHAFT/PADDLE HOLDERS

Ideal for both basket shaft and paddle storage.

Key Benefits:

- Prevents shafts/paddles from becoming bent or scratched
- Allows quick and easy transport of many shafts/paddles
- Handy end plate to stop shafts/paddles sliding out when carrying
- Holds most lengths and types of basket shafts and paddles
- Non-corrosive, quality plastic construction
- Space-saving, attractive design
- Available in both 12 and 16 shaft capacities

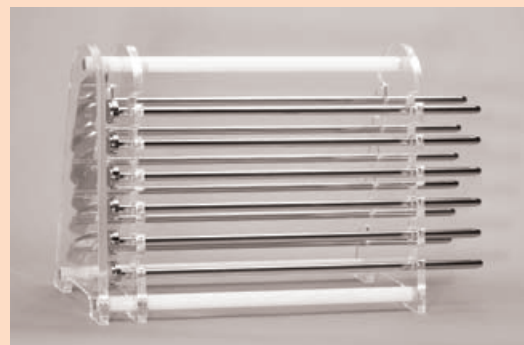

Dual Purpose: The Basket Shaft/Paddle Holders are designed for optimal handling and storage of both basket shafts and paddles. Why not use one to keep a set of both paddles and basket shafts next to each bath?

Part No.	Description	OEM Ref
PADHLD-12A	12 Position Paddle/Shaft Holder	QLA
PADHLD-16A	16 Position Paddle/Shaft Holder	QLA

POLISHED STAINLESS STEEL PADDLE (EPD SERIES)



PTFE COATED PADDLE (NPD SERIES)



SOLID FLUOROPOLYMER PADDLE (TPD SERIES)

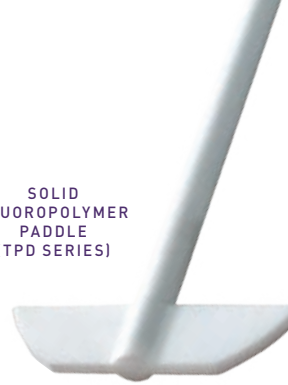

AGILENT COMPATIBLE PADDLES (INCLUDES LEGACY VANKEL)

Part No.	Description	OEM Ref
EPD013-01	14.5" (370mm) Paddle for V-Series, Electropolished 316 SS, Serialized	13-3590
EPD015-01	15" (380mm) Paddle, Electropolished 316 SS, Serialized	12-1030
EPD019-01	19" (480mm) Paddle, Electropolished 316 SS, Serialized	12-1040
EPD021-01	21" (535mm) Paddle, Electropolished 316 SS, Serialized	13-3595
EPD024-01	24" (610mm) Paddle, Electropolished 316 SS, Serialized	13-3597
NPD013-01	14.5" (370mm) Paddle for V-Series, PTFE coated over 316 SS, Serialized	13-3589
NPD015-01	15" (380mm) Paddle, PTFE coated over 316 SS, Serialized	12-1000
NPD019-01	19" (480mm) Paddle, PTFE coated over 316 SS, Serialized	12-1010
NPD021-01	21" (535mm) Paddle, PTFE coated over 316 SS, Serialized	13-3594
NPD024-01	24" (610mm) Paddle, PTFE coated over 316 SS, Serialized	13-3596
TPD013-01	14.5" (370mm) Paddle for V-Series, Solid Molded Fluoropolymer, One Piece Design, Serialized	QLA
TPD015-01	15" (380mm) Paddle, Solid Molded Fluoropolymer, One Piece Design, Serialized	QLA
TPD019-01	19" (480mm) Paddle, Solid Molded Fluoropolymer, One Piece Design, Serialized	QLA
TPD021-01	21" (535mm) Paddle, Solid Molded Fluoropolymer, One Piece Design, Serialized	QLA

DISTEK COMPATIBLE PADDLES

Part No.	Description	OEM Ref
EPD016-02	16.5" (420mm) Paddle, Electropolished 316 SS, Serialized	QLA
NPD016-02	16.5" (420mm) Paddle, PTFE coated over 316 SS, Serialized	2821-0171
TPD016-02	16.5" (420mm) Paddle, Solid Molded Fluoropolymer, One Piece Design, Serialized	QLA
SHFT16.5-DK	16.5" (420mm) Detachable Shaft, 316 SS, Serialized	2800-0165
SHFT21-DK	21" (535mm) Detachable Shaft, 316 SS, Serialized	2800-0334
SHFT21-NPD	21" (535mm) Detachable Shaft, PTFE coated over 316 SS, Serialized	2800-0334-T
ORING-SHFT	Black Viton O-Ring for Distek detachable shafts (Pack/12)	5570-8044
PDLBLD-DK	Paddle Blade, Electropolished 316 SS, Serialized	3251-1050
PDLBLD-NPD	Paddle Blade, PTFE coated over 316SS, Serialized	3251-1050-T
TUMSCR-DK	Shaft Collar with Thumb Screw for 2100 Series	2821-0094

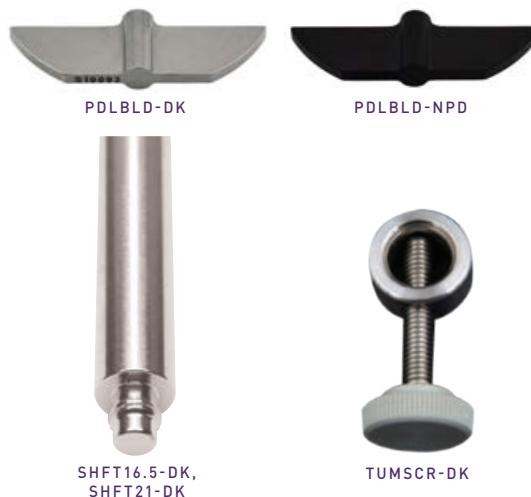

HANSON (SR8-PLUS) COMPATIBLE PADDLES

Part No.	Description	OEM Ref
EPD016-01	16" (405mm) Paddle, Electropolished 316 SS, Serialized	65-700-036
NPD016-01	16" (405mm) Paddle, PTFE coated over 316 SS, Serialized	QLA
TPD016-01	16" (405mm) Paddle, Solid Molded Fluoropolymer, One Piece Design, Serialized	72-800-456
TPD018-01	18" (460mm) Paddle, Solid Molded Fluoropolymer, One Piece Design, Serialized	72-800-461

SOTAX COMPATIBLE PADDLES

Part No.	Description	OEM Ref
TPD012-ST	11.85" (300mm) Paddle with 10mm OD, Solid Molded Fluoropolymer, One Piece Design, Serialized	QLA

Note: Hanson Vision 2-piece Shafts can be found in SPIN SHAFT Section, page 14.



SPIN SHAFT ACCESSORIES

THE SPIN SHAFT Apparatus 1 & 2

Spin On/Off Shafts for Apparatus 1 & 2 offer a quick, convenient change between paddle and basket methods without the need to reset the shaft height.

These two-piece basket/paddle/cylinder shafts join above the media to prevent potential contamination.

KEY CONSIDERATIONS

Spin Shaft Features:

- Spin On/Off Shafts may be used on any Agilent/VanKel, Distek, Erweka, or Hanson dissolution instruments.
- Distek's primary design is the bottom detachable basket hub and paddle blade but QLA also manufactures Spin On/Off Shafts for Distek 2100 and 2500 baths as well.
- It is unnecessary to remove the shaft when changing from APP 1 to APP 2.
- There is no need to readjust shaft height or the locking mechanism.
- The attachment connection for Spin On/Off Shafts is located outside the media, eliminating any chance of contamination.
- Precision manufacturing has assured USP compliance and detachable components meet USP specifications.
- Spin On/Off Shafts are engineered to minimize the risk of cross-threading and ensure a secure connection.
- Wobble data is well within USP tolerance.

AGILENT COMPATIBLE SPIN SHAFT ACCESSORIES (INCLUDES LEGACY VANKEL)

Part No.	Description	OEM Ref
SPNSHT-13	Spin ON/OFF 14.5" (370mm) Upper Shaft for V-Series, 316 SS, Serialized (when fully assembled)	QLA
SPNSHT-15	Spin ON/OFF 15" (380mm) Upper Shaft, 316 SS, Serialized (when fully assembled)	13-3612
SPNSHT-19	Spin ON/OFF 19" (480mm) Upper Shaft, 316 SS, Serialized (when fully assembled)	12-1401
SPNSHT-21	Spin ON/OFF 21" (535mm) Upper Shaft, 316 SS, Serialized (when fully assembled)	13-3613
SPNSHT-24	Spin ON/OFF 24" (610mm) Upper Shaft, 316 SS, Serialized (when fully assembled)	13-3614
SPNBSK-01	Spin ON/OFF Basket Shaft, Spring Clip Style, 316 SS, Serialized	13-3631
SPNRNG-01	Spin ON/OFF Basket Shaft, Push-On Style for VanKel, 316 SS, Serialized	12-1431
SPNEPD-01	Spin ON/OFF Paddle, Electropolished 316 SS, Serialized	13-3603
SPNNPD-01	Spin ON/OFF Paddle, PTFE Coated over 316 SS, Serialized	13-3602
SPNTPD-01	Spin ON/OFF Paddle, Solid Molded Fluoropolymer, One Piece Design, Serialized	QLA

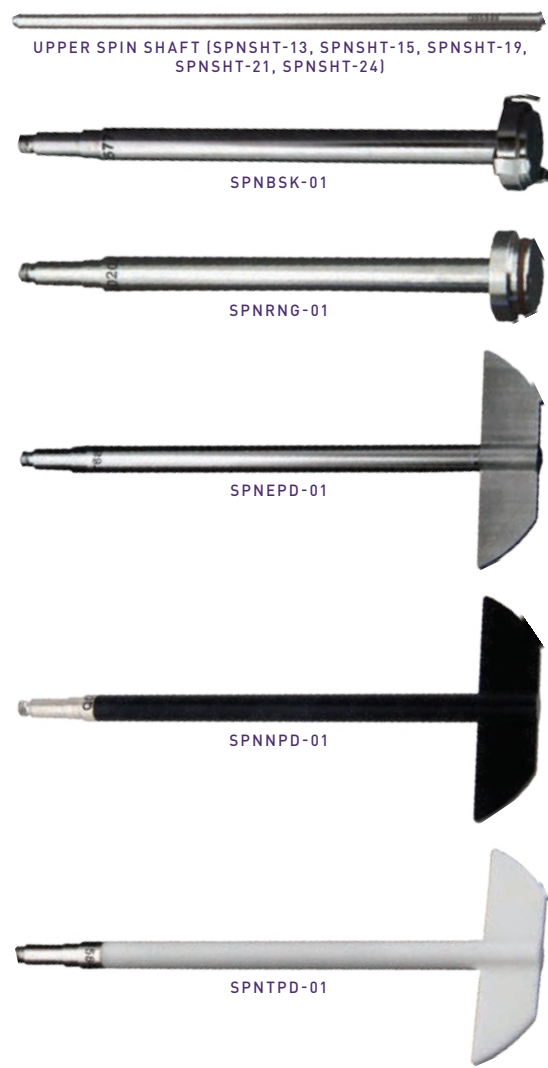

Note: All spin shafts are laser marked with a unique serial number and come with COC.

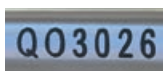

DISTEK

COMPATIBLE SPIN SHAFT ACCESSORIES

Part No.	Description	OEM Ref
SPNSHT-16.5	Spin ON/OFF 16.5" (420mm) Upper Shaft, 316 SS, Serialized (when fully assembled)	QLA
SPNSHT-21	Spin ON/OFF 21" (535mm) Upper Shaft, 316 SS, Serialized (when fully assembled)	QLA
SPNRNG-DK	Spin ON/OFF Basket Shaft, Standard Push-On Style for Distek, 316 SS, Serialized	QLA
SPNEPD-01	Spin ON/OFF Paddle, Electropolished 316 SS, Serialized	QLA
SPNNPD-01	Spin ON/OFF Paddle, PTFE Coated over 316 SS, Serialized	QLA
SPNTPD-01	Spin ON/OFF Paddle, Solid Molded Fluoropolymer, One Piece Design, Serialized	QLA

ERWEKA

COMPATIBLE SPIN SHAFT ACCESSORIES

Part No.	Description	OEM Ref
SPNSHT-7EW	Spin ON/OFF 7" (180mm) Upper Shaft for Low Head, 316 SS, Serialized	QLA
SPNSHT-15EW	Spin ON/OFF 15" (380mm) Upper Shaft for High Head, 316 SS, Serialized	QLA
SPNBSK-EW	Spin ON/OFF Basket Shaft, Spring Clip Style, 316 SS, Serialized	QLA
SPNEPD-EW	Spin ON/OFF Paddle, Electropolished 316 SS, Serialized	QLA
SPNTPD-EW	Spin ON/OFF Paddle, Solid Molded Fluoropolymer, One Piece Design, Serialized	QLA

HANSON

COMPATIBLE SPIN SHAFT ACCESSORIES

SR8-Plus

Part No.	Description	OEM Ref
SPNSHT-16	Spin ON/OFF 16" (405mm) Upper Shaft, 316 SS, Serialized (when fully assembled)	QLA
SPNBSK-HR	Spin ON/OFF Basket Shaft, Spring Clip Style, 316 SS, Serialized	QLA
SPNEPD-01	Spin ON/OFF Paddle, Electropolished 316 SS, Serialized	QLA
SPNNPD-01	Spin ON/OFF Paddle, PTFE Coated over 316 SS, Serialized	QLA
SPNTPD-01	Spin ON/OFF Paddle, Solid Molded Fluoropolymer, One Piece Design, Serialized	QLA

SPIN SHAFT TIGHTENING AND LOOSENING TOOL

- Provides for a secure connection and ensures the 2 piece shaft doesn't come loose or detached during operation
- Rubber lined for extra grip and will not scratch or damage the shaft
- Use two tools for best results.

Part No.	Description	OEM Ref
SHFTOOL	Spin Shaft Tightening/ Loosening Tool	QLA



Vision

Part No.	Description	OEM Ref
74-105-050	10" (255mm) Upper Spin Shaft, 316 SS, Serialized	74-105-050
74-205-050	15" (380mm) Upper Spin Shaft, 316 SS, Serialized	74-205-050
74-105-251	Spin Basket Shaft, Spring Clip Style, 316 SS, Serialized	74-105-251
74-105-202	Spin Paddle, Electropolished 316 SS, Serialized	74-105-202
74-105-201	Spin Paddle, Solid Molded Fluoropolymer, One Piece Design, Serialized	74-105-201
74-105-371	Spin Basket Shaft for 2L, Spring Clip Style, 316 SS, Serialized	74-105-371
74-105-361	Spin Paddle for 2L, Electropolished 316 SS, Serialized	74-105-361
74-105-351	Spin Paddle for 2L, Solid Molded Fluoropolymer, One Piece Design, Serialized	74-105-351

ULTRACENTER™ PRECISION TAPERED SHAFTS

Patent Pending

QLA UltraCenter™ Precision Tapered upper and lower shafts provide a significantly more accurate paddle and/or basket shaft assembly. The tapered fit between the upper and lower shaft results in an extremely concentric assembly with far less wobble. They were specifically designed to complement QLA AccuCenter™ Brackets and UltraCenter™ Vessels. UltraCenter™ upper and lower shafts are interchangeable. These shafts are another QLA innovative dissolution component developed to help achieve Enhanced Mechanical Calibration in accordance with the current ASTM standard. Dissolution instruments calibrated to this standard do not need further calibration with USP calibrator tablets.

Part No.	Description	OEM Ref
ASTMSHT-13	UltraCenter Precision Tapered 14.5" (370mm) Upper Spin Shaft, 316 SS, Serialized (when fully assembled)	QLA
ASTMSHT-15	UltraCenter Precision Tapered 15" (380mm) Upper Spin Shaft, 316 SS, Serialized (when fully assembled)	QLA
ASTMSHT-16	UltraCenter Precision Tapered 16" (405mm) Upper Spin Shaft, 316 SS, Serialized (when fully assembled)	QLA
ASTMSHT-16.5	UltraCenter Precision Tapered 16.5" (420mm) Upper Spin Shaft, 316 SS, Serialized (when fully assembled)	QLA
ASTMSHT-19	UltraCenter Precision Tapered 19" (480mm) Upper Spin Shaft, 316 SS, Serialized (when fully assembled)	QLA
ASTMSHT-21	UltraCenter Precision Tapered 21" (535mm) Upper Spin Shaft, 316 SS, Serialized (when fully assembled)	QLA
ASTMSHT-24	UltraCenter Precision Tapered 24" (610mm) Upper Spin Shaft, 316 SS, Serialized (when fully assembled)	QLA
SPNSK-ASTM	UltraCenter Precision Tapered Spin Basket, Spring Clip Style, 316 SS, Serialized	QLA
SPNEPD-ASTM	UltraCenter Precision Tapered Spin Paddle, Electropolished 316 SS, Serialized	QLA
SPNNPD-ASTM	UltraCenter Precision Tapered Spin Paddle, PTFE Coated over 316 SS, Serialized	QLA
SPNTPD-ASTM	UltraCenter Precision Tapered Spin Paddle, Solid Molded Fluoropolymer, One Piece Design, Serialized	QLA

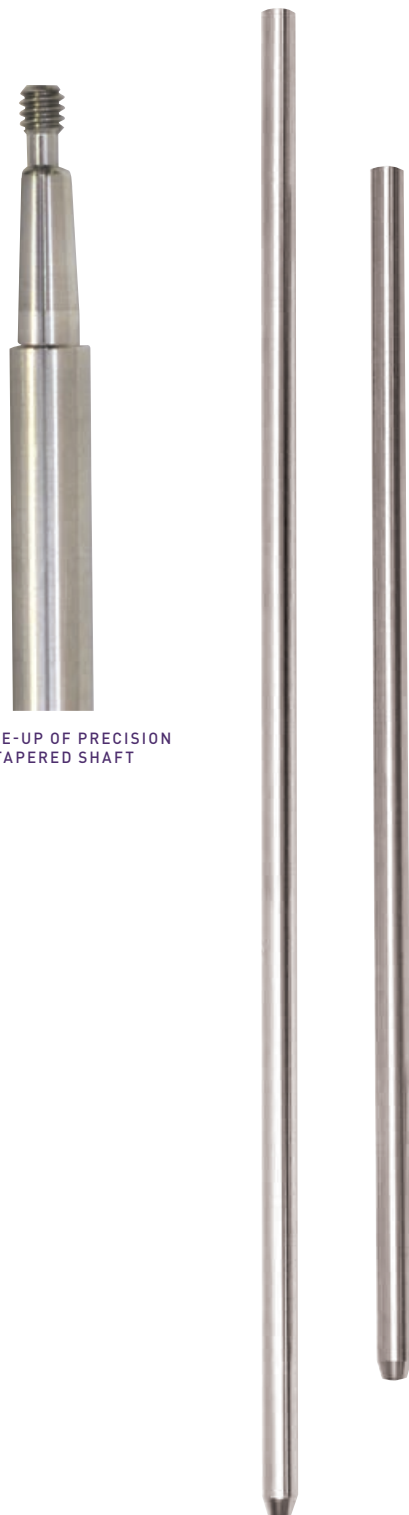

CLOSE-UP OF PRECISION TAPERED SHAFT



SPIN PADDLES AND BASKET SHAFT

UPPER SPIN SHAFTS

CAPSULE SINKERS

THE SINKER

Floating tablets rarely dissolve at a reproducible rate. Using a sinker in Apparatus 2 fixes the tablet to a certain point and aids reproducibility. Sinkers can also be useful where tablets may stick to the sides of the vessel.

USP 711 States: "A small, loose piece of non-reactive material such as not more than a few turns of wire helix may be attached to dosage units that would otherwise float. Other validated sinker devices may be used."

Once a sinker design is selected for a particular application, the dimensions and drawings should be recorded to ensure uniformity in the procedure.

KEY CONSIDERATIONS

Inevitably, home-made sinkers tend not to be reproducible and so commercially available sinkers are quite popular. The choice of sinker will depend on the tablet or capsule.

General Guidelines:

- **Sinker Size** — The sinker should have minimal surface contact with the tablet as this can affect the dissolution rate. Sinkers are available in different sizes to accommodate most capsule/tablet dimensions. See the sinker and capsule guides on pages 18 – 19.
- **Sinker Weight** — Should be heavy enough to ensure that the tablet sinks to the bottom of the vessel and doesn't move for the duration of the test.
- **PTFE Coated Sinkers** — Can be used where there may be a reaction between steel and the tablet. They also work well with magnetic retrievers.
- **Uncoated** — 316 stainless steel sinkers are more durable than coated sinkers.
- **Basket Sinkers** — Ideal for coin shaped tablets but care should be taken that the outer coating of the tablet does not clog the mesh.
- **Wire Spirals** — Should be as wide as practically possible to avoid clogging which would affect the dissolution rate.

OEM Key

- A** AGILENT
- S** SOTAX

PRONGED SINKERS

Part No.	Description	OEM Ref
CAPWHT-VK	3 Pronged Capsule Sinker, Plastic	12-3050 A
MAGWHT-VK	3 Pronged Capsule Sinker with Magnetic Legs, Plastic	12-3056 A
CAPWHT-SV	3 Pronged Capsule Sinker, 316 SS	QLA



CAPWHT-VK,
MAGWHT-VK



CAPWHT-SV

BASKET SINKERS

Part No.	Description	OEM Ref
CUSBSK-JP	Japanese Pharmacopeia Basket Sinker, 316 SS (same dimensions as shown in USP)	12-3070 A
CUSBSK-JPMAG	Magnetic Japanese Basket Sinker, 316 SS (same dimensions as shown in USP)	QLA
CUSBSK-ALF	Alfuzosin Hydrochloride Cylinder Sinker, 316 SS	QLA
BSK008-01	8 Mesh Basket Sinker, 316 SS, 1.06" (26.9mm) L x .62" (15.7mm) W capacity	QLA
BSK008-JP	8 Mesh Basket Sinker, 316 SS, .90" (22.9mm) L x .51" (12.9mm) W capacity	QLA
SNK008-VK	8 Mesh Sinker Basket with Lid, 316 SS	12-3062 A
SNK010-VK	10 Mesh Sinker Basket with Lid, 316 SS	12-3060 A
SNK020-VK	20 Mesh Sinker Basket with Lid, 316 SS	12-3063 A
SNK040-VK	40 Mesh Sinker Basket with Lid, 316 SS	12-3064 A
SNK080-VK	80 Mesh Sinker Basket with Lid, 316 SS	QLA



CUSBSK-JP,
CUSBSK-JPMAG

CUSBSK-ALF

BSK008-01

BSK008-JP



SNK008-VK



SNK010-VK



SNK040-VK

A QLA PERFECTED PRODUCT! QLA manufactures Japanese Sinker Baskets in strict conformance to USP and also offers a magnetic version for automatic retrieval systems. QLA's Japanese Sinker Baskets are made with extreme precision and offer coil spacing and vertical wire placement unmatched in accuracy by any other dissolution accessories manufacturer.

SPIRAL SINKERS

Part No.	Description	OEM Ref
CAPWHT-2S	Spiral Capsule Sinkers, 316 SS, .84" (21.3mm) L x .37" (9.4mm) W capacity, 8.5 coils	QLA
CAPWHT-02	Spiral Capsule Sinkers, PTFE Coated Music Wire, .84" (21.3mm) L x .37" (9.4mm) W capacity, 8.5 coils	QLA
CAPWHT-4S	Spiral Capsule Sinkers, 316 SS, .84" (21.3mm) L x .385" (9.8mm) W capacity, 5 coils	QLA
CAPWHT-04	Spiral Capsule Sinkers, PTFE Coated Music Wire, .84" (21.3mm) L x .385" (9.8mm) W capacity, 5 coils	QLA
CAPWHT-LG	Spiral Capsule Sinkers, PTFE Coated Music Wire, 1.10" (27.9mm) L x .41" (10.4mm) W capacity, 6.5 coils	QLA
CAPWHT-XL	Spiral Capsule Sinkers, PTFE Coated Music Wire, 1.15" (29.2mm) L x .465" (11.8mm) W capacity, 5.5 coils	QLA
CAPWHT-XLS	Spiral Capsule Sinkers, 316 SS, 1.15" (29.2mm) L x .465" (11.8mm) W capacity, 5.5 coils	QLA
CAPWHT-XLSS	Spiral Capsule Sinkers, 316 SS, .885" (22.5mm) L x .465" (11.8mm) W capacity, 3 coils	QLA
CAPWHT-XS	Spiral Capsule Sinkers, 316 SS, .885" (22.5mm) L x .575" (14.6mm) W capacity, 8.5 coils	QLA
CAPWST-15	Spring Style Capsule Sinkers, 316 SS, .61" (15.5mm) L x .19" (5mm) W capacity	8280 
CAPWST-18	Spring Style Capsule Sinkers, 316 SS, .71" (18mm) L x .24" (6mm) W capacity	7346 
CAPWST-19	Spring Style Capsule Sinkers, 316 SS, .76" (19.3mm) L x .28" (7mm) W capacity	8283 
CAPWST-23	Spring Style Capsule Sinkers, 316 SS, .91" (23mm) L x .31" (8mm) W capacity	6881 
CAPWST-31	Spring Style Capsule Sinkers, 316 SS, 1.22" (31mm) L x .43" (11mm) W capacity	7349 
CAPWHT-TR	Time Release Capsule Sinkers, 316 SS	QLA
CAPWHT-PC	Breath Film Sinkers, 316 SS	QLA



CAPWHT-2S



CAPWHT-02



CAPWHT-4S



CAPWHT-04

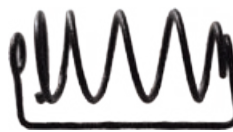

CAPWHT-LG



CAPWHT-XL



CAPWHT-XLS



CAPWHT-XLSS



CAPWHT-XS



CAPWST-31



CAPWHT-TR



CAPWHT-PC



CAPWST-15



CAPWST-18



CAPWST-19



CAPWST-23

TYPE 316 STAINLESS STEEL WIRE

This wire is ideal for winding your own capsule sinkers, especially if you have non-standard size capsules.

Part No.	Description	OEM Ref
WIRESK-VK	316 SS Sinker Wire, .032" (.81mm) dia., 50' (15m) Roll	12-3000 

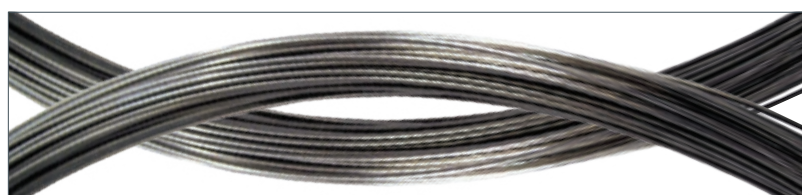

O-RING SINKERS

O-ring sinkers feature an expandable rubber ring. This lets the capsule swell while still maintaining adequate sinking.

Part No.	Description	OEM Ref
CAPWHT-S99	O-Ring Sinkers, 316 SS	8399 



CAPWHT-S99

SINKER TYPE

	PART NUMBER	STYLE	MATERIAL	COATING	INSIDE DIAMETER	
					(inches)	(mm)
BASKET	CUSBSK-JP	Basket, JP	316 SS	-	0.470	11.9
	BSK008-01	Basket, 8 Mesh	316 SS	-	0.620	15.7
	BSK008-JP	Basket, 8 Mesh	316 SS	-	0.510	12.9
	SNK008-VK	Basket, 8 Mesh	316 SS	-	0.795	20.2
	SNK010-VK	Basket, 10 Mesh	316 SS	-	0.795	20.2
	SNK020-VK	Basket, 20 Mesh	316 SS	-	0.795	20.2
	SNK040-VK	Basket, 40 Mesh	316 SS	-	0.795	20.2
	SNK080-VK	Basket, 80 Mesh	316 SS	-	0.795	20.2
PRONGED	CAPWHT-VK	3 Prong	Nylon / PP	-	0.375	9.5
	MAGWHT-VK	3 Prong	Nylon / PP	-	0.375	9.5
	CAPWHT-SV	3 Prong	316 SS	-	0.275	7.0
O-RING	CAPWHT-S99	O-Ring	316 SS	-	0.230	5.8
SPIRAL	CAPWHT-TR	Butterfly	316 SS	-	0.211	5.4
	CAPWHT-PC	Strip Film	316 SS	-	0.425	10.8
	CAPWST-15	Helix	316 SS	-	0.197	5.0
	CAPWHT-04	Helix	Music Wire	PTFE	0.385	9.8
	CAPWHT-4S	Helix	316 SS	-	0.385	9.8
	CAPWHT-LG	Helix	Music Wire	PTFE	0.410	10.4
	CAPWHT-XL	Helix	Music Wire	PTFE	0.465	11.8
	CAPWHT-XLS	Helix	316 SS	-	0.465	11.8
	CAPWHT-XLSS	Helix	316 SS	-	0.465	11.8
	CAPWST-18	Helix	316 SS	-	0.236	6.0
	CAPWST-19	Helix	316 SS	-	0.276	7.0
	CAPWHT-2S	Helix	316 SS	-	0.370	9.4
	CAPWHT-02	Helix	Music Wire	PTFE	0.370	9.4
	CAPWHT-XS	Helix	316 SS	-	0.575	14.6
	CAPWST-23	Helix	316 SS	-	0.315	8.0
CAPWST-31	Helix	316 SS	-	0.433	11.0	
WIRE	WIRESK-VK	Sinker Wire 50'	316 SS	-	-	-

CAPSULES

CAPSULE SIZE	LENGTH		DIAMETER	
	(inches)	(mm)	(inches)	(mm)
000	1.029	26.1	0.390	9.91
00E	1.012	25.7	0.336	8.53
00	0.917	23.3	0.336	8.53
0E	0.909	23.1	0.301	7.65
0	0.854	21.7	0.301	7.65
1	0.765	19.4	0.272	6.91
2	0.709	18.0	0.250	6.35
3	0.626	15.9	0.229	5.83
4	0.563	14.3	0.209	5.32
5	0.437	11.1	0.193	4.91

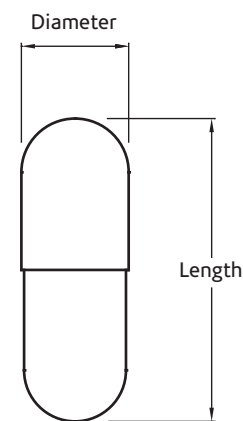

INSIDE LENGTH		WIRE DIAMETER		MAX CAPSULE SIZE	NO. OF COILS
(inches)	(mm)	(inches)	(mm)		
1.000	25.4	0.040	1.00	00	-
1.060	26.9	0.028	0.71	000	-
0.900	22.9	0.028	0.71	1	-
0.500	12.7	0.028	0.71	00	-
0.500	12.7	0.025	0.64	00	-
0.500	12.7	0.016	0.41	00	-
0.500	12.7	0.010	0.25	00	-
0.500	12.7	0.007	0.18	00	-
1.000	25.4	-	-	1 (min=3)	-
1.000	25.4	-	-	1 (min=3)	-
1.000	25.4	-	-	1 (min=3)	-
0.900	22.9	-	-	0	-
0.375	9.5	0.030	0.76	-	-
0.425	10.8	0.037	0.94	-	-
0.610	15.5	0.016	0.41	5	6
0.840	21.3	0.043	1.09	0	5
0.840	21.3	0.047	1.19	0	5
1.100	27.9	0.043	1.09	000	6.5
1.150	29.2	0.043	1.09	000	5.5
1.150	29.2	0.043	1.09	000	5.5
0.885	22.5	0.043	1.09	Special	3
0.709	18	0.016	0.41	3	8
0.760	19.3	0.016	0.41	2	8
0.840	21.3	0.043	1.09	0	8.5
0.840	21.3	0.047	1.19	0	8.5
0.885	22.5	0.047	1.19	Special	8.5
0.905	23	0.016	0.41	0	9
1.220	31	0.031	0.78	000	11
-	-	0.032	0.81	-	-

CAPSULES Shown at Actual Size

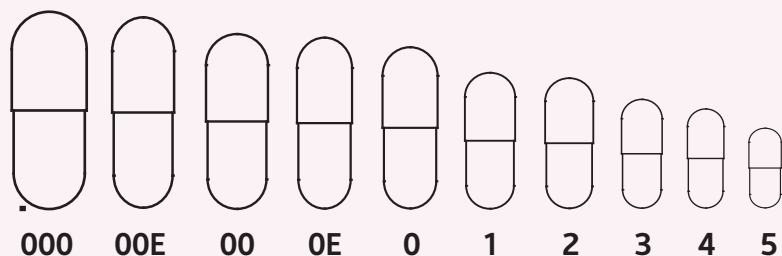

Custom Design and Fabrication

QLA provides design and fabrication services including custom sinkers, to any specification.

We can advise you on any project that comes up.

Please speak with your QLA Sales Rep about your requirements.

VESSELS

THE VESSEL

Good dissolution vessels are critical in obtaining correct and reproducible results and are sometimes overlooked as a key element in the dissolution test.

All vessels meet the physical dimensions of the USP and have a hemispherical bottom which means that they should be perfectly rounded with no obvious defects of the glass on the inside. Wall thicknesses should be even and reproducible.

Although the USP states the dimensions for vessels, the tolerances are actually quite wide, meaning vessels associated with various dissolution baths are not dimensionally the same. Replacing a vessel with one not specifically designed for the instrument could impair vessel centering and paddle height. Also larger or smaller inside diameters can affect vessel hydrodynamics.

Note: QLA vessels are acid etched, or laser marked on plastic rim, with a unique serial number and come with a Certificate of Conformance (COC), where applicable.

IMPROVE YOUR DISSOLUTION RESULTS WITH QLA ULTRACENTER™ PRECISION VESSELS



UltraCenter™ Precision Vessels are available in clear and amber, Glass Rim, Plastic Rim and PEAK versions. QLA's molded PEAK vessels are Patent Pending.

Small variations in vessel dimensions have been shown by the USP and others to contribute to excessive changes in dissolution rates. UltraCenter™ Precision Vessels are produced using a unique molded process which provides a precise and consistent inside diameter and spherical radius resulting in a more reproducible dissolution profile. They are compatible with most dissolution baths and have been adopted as a standard by many major pharmaceutical companies.

When used in conjunction with QLA's AccuBracket™, your lab will achieve the highest level of vessel centering accuracy available. See MISC DISSOLUTION ACCESSORIES Section, page 43.

QLA Certificates

COC

All serialized QLA parts — like baskets, paddles and vessels — come with a Certificate of Conformance (COC) at no extra charge.

COA

Certificate of Analysis (COA) is available for all QLA serialized parts — like baskets, paddles and vessels — for an additional fee.



KEY CONSIDERATIONS

Glass Vessels benefit from good thermal conductivity (it is often necessary to have the temperature of the water bath as much as 2°C higher than the analysis temperature when using plastic vessels). Another advantage of using glass vessels is their high resistance to scratching, which means they have to be replaced less frequently.

Amber Vessels can be used if light sensitive compounds are being tested. They are available in glass and plastic.

Plastic Vessels are very reproducible because they are made from a mold rather than hand formed. They also have feet which allows them to stand upright independently. The biggest disadvantage is that plastic is very prone to scratching and cracking, requiring frequent replacement. Plastic vessels have the advantage over glass in that they are very reproducible. The vessel is made from a mold rather than hand-formed. This reduces possible errors in setting the paddle height and centering and can give very reproducible results. Another advantage of plastic vessels is that they have feet so they can stand upright independently.

Plastic Rim Vessels were developed to help minimize glass rim breakage that can occur during normal laboratory use. They are produced by a unique proprietary bonding method using high impact plastic which eliminates rim breakage and safety concerns. All QLA Plastic Rim Vessels are dishwasher safe. Plastic Rim Vessels come in both Standard and UltraCenter™ Precision versions. Serial numbers are laser marked on the plastic rim only.

Peak Vessels are designed to prevent cone formation at the base of the vessel. An undesirable poorly stirred cone shaped region can develop under the paddle during USP Apparatus 2 dissolution tests. Peak vessels have a cone shape molded into the bottom of the vessel that improves the hydrodynamics around the dosage form and leads to more reproducible dissolution rates. The peak effectively displaces the unstirred cone, forcing the material tested into the region of appropriate hydrodynamics, where all surfaces of the dosage are constantly and uniformly exposed to the moving medium. Peak vessels do not comply with USP specifications and cannot be substituted in existing applications.

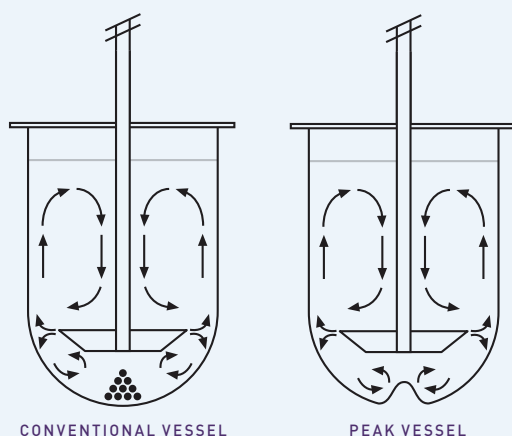

GLASS VESSEL

AMBER VESSEL



PLASTIC VESSEL



PLASTIC RIM VESSEL



PEAK VESSEL

QLA's UltraCenter™ Precision PEAK vessels are Patent Pending.

AGILENT COMPATIBLE VESSELS
 (INCLUDES LEGACY VANKEL)

UltraCenter™ Precision Vessels

Part No.	Description	OEM Ref
ASTM900-UN	1000mL Clear UltraCenter Precision Glass Vessel, Serialized	QLA
ASTM900-UNAM	1000mL Amber UltraCenter Precision Glass Vessel, Serialized	QLA
ASTM900-UNP	1000mL Clear UltraCenter Precision Glass Vessel w/Plastic Rim, Serialized	QLA
ASTM900-AUNP	1000mL Amber UltraCenter Precision Glass Vessel w/Plastic Rim, Serialized	QLA
ASTM900-VK	1000mL Clear UltraCenter Precision Glass Vessel for TruCenter, No Collar, Serialized	QLA
ASTM900-AVK	1000mL Amber UltraCenter Precision Glass Vessel for TruCenter, No Collar, Serialized	QLA
ASTM900-70XDS	1000mL Clear UltraCenter Precision Glass Vessel w/Plastic Rim for 708/709-DS, Serialized	QLA
ASTM900-A70XDS	1000mL Amber UltraCenter Precision Glass Vessel w/Plastic Rim for 708/709-DS, Serialized	QLA
ASTM9PK-UNP	1000mL Clear UltraCenter Precision Glass PEAK Vessel w/Plastic Rim, Serialized	QLA
ASTM9PK-AUNP	1000mL Amber UltraCenter Precision Glass PEAK Vessel w/Plastic Rim, Serialized	QLA
ASTM9PK-70XDS	1000mL Clear UltraCenter Precision Glass PEAK Vessel w/Plastic Rim for 708/709-DS, Serialized	QLA
ASTM9PK-A70XDS	1000mL Amber UltraCenter Precision Glass PEAK Vessel w/Plastic Rim for 708/709-DS, Serialized	QLA

Standard Vessels

Part No.	Description	OEM Ref
GLA100-VK	100mL Clear Glass Vessel	12-5040
GLA200-VK	200mL Clear Glass Vessel	12-5050
GLA200-AV	200mL Amber Glass Vessel	12-5051
GLA500-01	500mL Clear Glass Vessel	12-5060
GLA500-AV	500mL Amber Glass Vessel	QLA
GLA900-01	1000mL Clear Glass Vessel, Serialized	12-5000

Standard Vessels: (Agilent) continued.

Part No.	Description	OEM Ref
GLA900-AV	1000mL Amber Glass Vessel, Serialized	12-5010
GLA900-UNP	1000mL Clear Glass Vessel w/Plastic Rim, Serialized	QLA
GLA900-AUNP	1000mL Amber Glass Vessel w/Plastic Rim, Serialized	QLA
GLA900-VK	1000mL Clear Glass Vessel for TruCenter, No Collar, Serialized	12-5035
GLA900-AVK	1000mL Amber Glass Vessel for TruCenter, No Collar, Serialized	12-5120
GLA900-70XDS	1000mL Clear Glass Vessel w/Plastic Rim for 708/709-DS, Serialized	12-5149
GLA900-A70XDS	1000mL Amber Glass Vessel w/Plastic Rim for 708/709-DS, Serialized	12-5152
GLA9PK-01	1000mL Clear Glass PEAK Vessel, Serialized	12-5500
GLA9PK-AV	1000mL Amber Glass PEAK Vessel, Serialized	12-5505
GLA9PK-UNP	1000mL Clear Glass PEAK Vessel w/Plastic Rim, Serialized	QLA
GLA9PK-AUNP	1000mL Amber Glass PEAK Vessel w/Plastic Rim, Serialized	QLA
GLA9PK-VK	1000mL Clear Glass PEAK Vessel for TruCenter, No Collar, Serialized	12-5125
GLA9PK-70XDS	1000mL Clear Glass PEAK Vessel w/Plastic Rim for 708/709-DS, Serialized	12-5153
GLA9PK-A70XDS	1000mL Amber Glass PEAK Vessel w/Plastic Rim for 708/709-DS, Serialized	12-5154
PLA900-01	1000mL Clear Plastic Vessel	12-5200
PLA900-AV	1000mL Amber Plastic Vessel	QLA
GLA02K-01	2000ml Clear Glass Vessel, Serialized	12-5070
ACCUBKT-VK	AccuCenter Bracket for Legacy VanKel and Agilent 708-DS baths	QLA
EZLBKT-01	Vessel Centering Bracket with 6 Replaceable Pins for Legacy VanKel baths	12-6050
EZLKIT-01	Vessel Centering Bracket Repair Kit (Set/12 Pins)	QLA
EZLPEG-01	Vessel Centering Bracket Peg	12-6065
KNOB-708	Vessel Clamp Knob for 708-DS baths	QLA



QLA UltraCenter™ Precision and Standard Vessels are available in clear and amber, Glass Rim, Plastic Rim and PEAK versions. QLA's molded PEAK vessels are Patent Pending.

DISTEK COMPATIBLE VESSELS

UltraCenter™ Precision Vessels

Part No.	Description	OEM Ref
ASTM900-UN	1000mL Clear UltraCenter Precision Glass Vessel, Serialized	QLA
ASTM900-UNAM	1000mL Amber UltraCenter Precision Vessel, Serialized	QLA
ASTM900-UNP	1000mL Clear UltraCenter Precision Glass Vessel w/Plastic Rim, Serialized	QLA
ASTM900-AUNP	1000mL Amber UltraCenter Precision Glass Vessel w/Plastic Rim, Serialized	QLA
ASTM9PK-UNP	1000mL Clear UltraCenter Precision Glass PEAK Vessel w/Plastic Rim, Serialized	QLA
ASTM9PK-AUNP	1000mL Amber UltraCenter Precision Glass PEAK Vessel w/Plastic Rim, Serialized	QLA

Standard Vessels

Part No.	Description	OEM Ref
GLA100-DK	100mL Clear Glass Vessel	QLA
GLA100-AD	100mL Amber Glass Vessel	QLA
GLA200-DK	200mL Clear Glass Vessel	QLA
GLA500-DK	500mL Clear Glass Vessel, No Ring	QLA
GLA500-AD	500mL Amber Glass Vessel, No Ring	QLA
GLA900-DK	1000mL Clear Glass Vessel, No Ring, Serialized	QLA
GLA900-DKP	1000mL Clear Premier Glass Vessel, No Ring, Serialized	3010-0096
GLA900-AD	1000mL Amber Glass Vessel, No Ring, Serialized	QLA
GLA9CR-DK	1000mL Clear Glass Vessel w/Acculign Ring, Serialized	3010-0093
GLA9CR-AD	1000mL Amber Glass Vessel w/Acculign Ring, Serialized	3010-0023
GLA900-UNP	1000mL Clear Glass Vessel w/Plastic Rim, Serialized	QLA
GLA900-AUNP	1000mL Amber Glass Vessel w/Plastic Rim, Serialized	QLA
GLA9PK-DK	1000mL Clear Glass PEAK Vessel w/Acculign Ring, Serialized	3010-0550
GLA9PK-UNP	1000mL Clear Glass PEAK Vessel w/Plastic Rim, Serialized	QLA
GLA9PK-AUNP	1000mL Amber Glass PEAK Vessel w/Plastic Rim, Serialized	QLA
PLA900-DK	1000mL Clear Plastic Vessel	3350-0095
PLA900-AD	1000mL Amber Plastic Vessel	QLA
GLA02K-DK	2000mL Clear Glass Vessel, No Ring, Serialized	3010-0285
GLA02K-AD	2000mL Amber Glass Vessel, No Ring, Serialized	3020-0327

Standard Vessels: (Distek) continued.

Part No.	Description	OEM Ref
ACCUBKT-DK	AccuCenter Bracket for Distek 2100 Series baths	QLA
ACCUBKT-DK2500	AccuCenter Bracket for Distek 2500 Series baths	QLA
ACCUBKT-IKIT2500	AccuCenter Bracket Installation Kit for Distek 2500 baths	QLA
RING01-DK	Acculign Vessel Centering Ring for Distek	3350-0096
VSCLIP-DK	Vessel Retainer Assembly for Distek 2100 and 6300 baths	2821-0257

ERWEKA COMPATIBLE VESSELS

UltraCenter™ Precision Vessels

Must use with QLA Part# RING-UCEW.

Part No.	Description	OEM Ref
ASTM900-UN	1000mL Clear UltraCenter Precision Glass Vessel, Serialized	QLA
ASTM900-UNAM	1000mL Amber UltraCenter Precision Vessel, Serialized	QLA
ASTM900-UNP	1000mL Clear UltraCenter Precision Glass Vessel w/Plastic Rim, Serialized	QLA
ASTM900-AUNP	1000mL Amber UltraCenter Precision Glass Vessel w/Plastic Rim, Serialized	QLA
ASTM9PK-UNP	1000mL Clear UltraCenter Precision Glass PEAK Vessel w/Plastic Rim, Serialized	QLA
ASTM9PK-AUNP	1000mL Amber UltraCenter Precision Glass PEAK Vessel w/Plastic Rim, Serialized	QLA

Standard Vessels

Part No.	Description	OEM Ref
GLA900-EW	1000mL Clear Glass Vessel, Serialized	80-000-1002
GLA900-AEW	1000mL Amber Glass Vessel, Serialized	80-000-1004
PLA900-EW	1000mL Clear Plastic Vessel	QLA
GLA02K-EW	2000mL Clear Glass Vessel, Serialized	80-000-2002
RING-UCEW	Vessel Hold Down Ring for UltraCenter Vessels on Erweka DT baths	QLA

HANSON

COMPATIBLE VESSELS

UltraCenter™ Precision Vessels for SR8-Plus

Part No.	Description	OEM Ref
ASTM900-UN	1000mL Clear UltraCenter Precision Glass Vessel, Serialized	QLA
ASTM900-UNAM	1000mL Amber UltraCenter Precision Glass Vessel, Serialized	QLA
ASTM900-UNP	1000mL Clear UltraCenter Precision Glass Vessel w/Plastic Rim, Serialized	QLA
ASTM900-AUNP	1000mL Amber UltraCenter Precision Glass Vessel w/Plastic Rim, Serialized	QLA
ASTM9PK-UNP	1000mL Clear UltraCenter Precision Glass PEAK Vessel w/Plastic Rim, Serialized	QLA
ASTM9PK-AUNP	1000mL Amber UltraCenter Precision Glass PEAK Vessel w/Plastic Rim, Serialized	QLA

Standard Vessels for SR8-Plus

Part No.	Description	OEM Ref
GLA500-HR	500mL Clear Glass Vessel	QLA
GLA900-HR	1000mL Clear Glass Vessel, Serialized	72-600-510
GLA900-AH	1000mL Amber Glass Vessel, Serialized	72-600-556
GLA900-UNP	1000mL Clear Glass Vessel w/Plastic Rim, Serialized	QLA
GLA900-AUNP	1000mL Amber Glass Vessel w/Plastic Rim, Serialized	QLA
GLA9PK-HR	1000mL Clear Glass PEAK Vessel w/ Ring, Serialized	95-590-047
GLA9PK-AH	1000mL Amber Glass PEAK Vessel w/ Ring, Serialized	95-590-048
GLA9PK-UNP	1000mL Clear Glass PEAK Vessel w/ Plastic Rim, Serialized	QLA
GLA9PK-AUNP	1000mL Amber Glass PEAK Vessel w/ Plastic Rim, Serialized	QLA
PLA900-HR	1000mL Clear Plastic Vessel	91-030-003
PLA900-AH	1000mL Amber Plastic Vessel	QLA
GLA02K-HR	2000ml Clear Glass Vessel, Serialized	72-600-509
ACCUBKT-HR	AccuCenter Bracket for Hanson SR8-Plus baths	73-101-519

UltraCenter™ Precision Vessels for Vision

Part No.	Description	OEM Ref
74-104-121	1000mL Clear UltraCenter Precision Glass Easi-Lock Vessel, Serialized	74-104-121
74-104-122	1000mL Amber UltraCenter Precision Glass Easi-Lock Vessel, Serialized	74-104-122

Standard Vessels for Vision

Part No.	Description	OEM Ref
74-104-101	1000mL Clear Glass Easi-Lock Vessel, Serialized	74-104-101
74-104-102	1000mL Amber Glass Easi-Lock Vessel, Serialized	74-104-102
74-104-131	1000mL Clear Glass PEAK Easi-Lock Vessel, Serialized	74-104-131
74-104-132	1000mL Amber Glass PEAK Easi-Lock Vessel, Serialized	74-104-132
74-104-111	2000mL Clear Glass Easi-Lock Vessel, Serialized	74-104-111
74-104-112	2000mL Amber Glass Easi-Lock Vessel, Serialized	74-104-112



QLA UltraCenter™ Precision and Standard Vessels are available in clear and amber, Glass Rim, Plastic Rim and PEAK versions. QLA's molded PEAK vessels are Patent Pending.

PHARMATEST COMPATIBLE VESSELS*

UltraCenter™ Precision Vessels: Contact your Sales Representative.

Standard Vessels *Vessels do not fit PTWS310.

Part No.	Description	OEM Ref
GLA900-PT	1000mL Clear Glass Vessel, Serialized	303-5225
GLA900-APT	1000mL Amber Glass Vessel, Serialized	303-5425
PLA900-PT	1000mL Clear Plastic Vessel	QLA
PLA900-AP	1000mL Amber Plastic Vessel	QLA

SOTAX COMPATIBLE VESSELS

UltraCenter™ Precision Vessels: Contact your Sales Representative.

Standard Vessels

Part No.	Description	OEM Ref
GLA900-ST	1000mL Clear Glass Vessel, Serialized	2503
GLA900-AST	1000mL Amber Glass Vessel, Serialized	2503-2

UNIVERSAL VESSEL STANDS

For the safe transportation and storage of vessels
 Due to their shape, dissolution vessels are difficult to hold securely. This can often result in scratched, chipped or even smashed vessels.

The noncorrosive rigid ABS plastic stands are available in 6 or 8 vessel capacities and can hold vessels from any dissolution bath manufacturer.

They can also be stacked together to save bench space and enable you to transport many vessels at a time.

Part No.	Description	OEM Ref
VESSTD-06H	6 Position Vessel Stand, Universal	QLA
VESSTD-08H	8 Position Vessel Stand, Universal	QLA

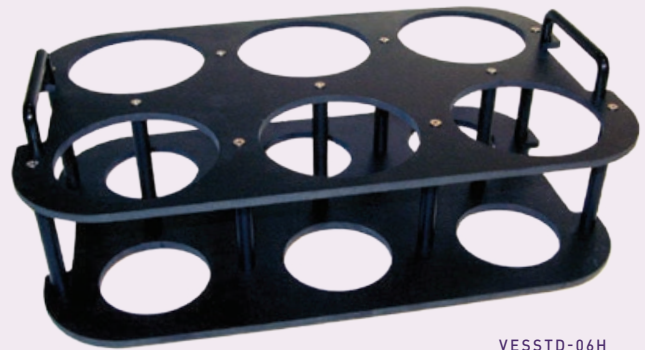

VESSEL COVERS

THE VESSEL COVER

The loss of media due to evaporation can be considerable. Vessel Covers should reduce these problems and provide openings to accommodate cannulas and stoppers. Cover styles include all common one-piece and hinged covers, as well as a unique rotary configuration.

KEY CONSIDERATIONS

Evaporation Losses are reduced by using vessel covers with a minimal open area during the test. Slots and holes for temperature verification, sample introduction and sample collection should be closed when not in use. These losses are further reduced when using conical shaped low evaporation covers.

Cannulas Stoppers — Cannulas can be used with stoppers during manual sampling to ensure that the sample is always taken from the same depth.

Vessel covers must have the appropriate hole for the stopper (which is attached to the cannula) to sit in. The stopper and cannula must match the vessel cover type. See page 28 for sampling cannula and stoppers.

AGILENT COMPATIBLE VESSEL COVERS (INCLUDES LEGACY VANKEL)

Part No.	Description	OEM Ref
COVERV-00	Low Evaporation Rotary Cover	QLA
COVERV-01	Clear Cover with Paddle Slot	12-6300
COVERV-02	Amber Cover with Paddle Slot	12-6320
COVERV-03	Clear Solid Cover	12-6330
COVERV-04	Clear Cover for Dosage Delivery Module	12-6310
COVERV-HG	Low Evaporation Clear Hinged Cover	QLA
COVERV-01SB	Clear Cover with Paddle Slot & Extra Hole for Stationary Basket	QLA
COVERV-LL	Low Evaporation Clear Cover, Conical Shape	12-0469
COVERV-LLHG	Low Evaporation Clear Hinged Cover, Conical Shape	12-6328
COVERV-LLSB	Low Evaporation Clear Cover for Stationary Baskets	QLA
COVERV-LLVS	Low Evaporation Clear Hinged Cover for TruCenter, Conical Shape	QLA
COVERV-LLVSB	Low Evaporation Clear Hinged Cover for TruCenter, Conical Shape & Extra Hole for Stationary Basket	QLA
COVERV-LLVSV	Low Evaporation Clear Hinged Cover for V-Series, Conical Shape	QLA
COVERV-708	Clear Hinged Cover for Agilent 708/ 709-DS	QLA
COVERV-6K	Clear Cover for VK 600/6000	QLA
ACCUCVR-LLV	Low Evaporation Clear Hinged Cover for ACCUBKT-VK & VK auto-sampler, Conical Shape	QLA
COVERD-01VKBKT	Clear Hinged Cover with Paddle Slot for ACCUBKT-VK & VK auto-sampler	QLA



COVERV-00



COVERV-01



COVERV-02



COVERV-03



COVERV-04

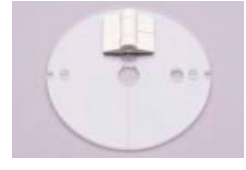

COVERV-HG



COVERV-01SB



COVERV-LL



COVERV-LLHG



COVERV-LLVS



COVERV-LLSB



COVERV-LLVSB



COVERV-LLVSV

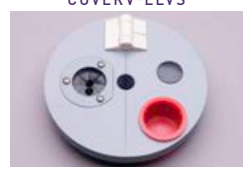

COVERV-708



ACCUCVR-LLV

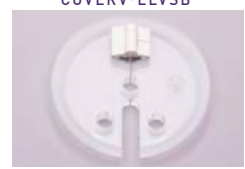

COVERD-01VKBKT

DISTEK COMPATIBLE VESSEL COVERS

Part No.	Description	OEM Ref
COVERD-00	Low Evaporation Rotary Cover	QLA
COVERD-01	Clear Hinged Cover	2800-0889
COVERD-02	Amber Hinged Cover	QLA
COVERD-04	Black Cast Acrylic Hinged Cover with Small Center Hole	2800-0854
COVERD-BK	Clear Hinged Cover with Large Center Hole for Easy Basket Access includes cap	2800-0870
COVERAD-BK	Amber Hinged Cover with Large Center Hole for Easy Basket Access includes cap	QLA
COVCAP-DK	Clear Cap for COVERD-BK cover	2800-0055
COVCAP-AD	Amber Cap for COVERAD-BK cover	QLA
COVERD-HG	Low Evaporation Clear Hinged Cover	QLA
COVDHG-SB	Clear Hinged Cover for Stationary Basket	2800-0881
COVPLG-7D	7th Position Cover Plug	3350-0109
COVPLG-DK	Probe Hole Plugs for Distek Covers	5720-4037
HINGE-DK	Plastic Hinge for Distek Covers	5560-6011



ERWEKA COMPATIBLE VESSEL COVERS

Part No.	Description	OEM Ref
COVERD-EW	Low Evaporation Clear Hinged Cover	QLA



HANSON COMPATIBLE VESSEL COVERS

Part No.	Description	OEM Ref
COVERH-00	Low Evaporation Rotary Cover	65-233-170
COVERH-01	Clear Cover with Paddle Slot	72-500-215
COVERH-02	Gray Cover with Paddle Slot	72-800-603
COVERH-03	Amber Cover with Paddle Slot	QLA
COVERH-04	Clear Solid Cover	QLA
COVERH-HG	Low Evaporation Clear Hinged Cover	95-590-046
COVERH-LL	Low Evaporation Clear Cover	QLA
COVER-HR	Easi-Lock Vessel Cover for Vision	74-104-151
COVHGH-SB	Clear Hinged Cover for Stationary Basket	QLA

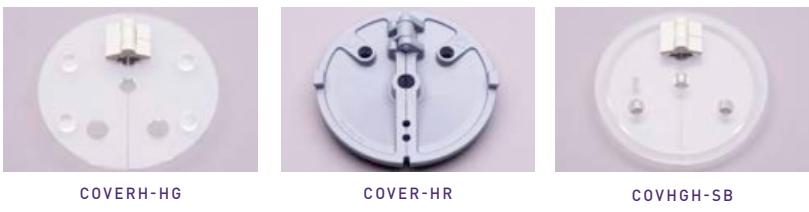

SAMPLING CANNULA

THE CANNULA

Almost every dissolution test relies on samples being taken to produce a result. It is important that the sampling method does not adversely affect the accuracy of the dissolution test. Sampling errors are very common and are often the cause of erroneous results.

The USP defines the sampling point as: "A zone half way between the top of the media and top of the paddle or basket not less than 1cm from the vessel wall. The sampling position is critical but so too is the type of sampling cannula (also known as a probe) used."

KEY CONSIDERATIONS

Sampling Position — The sampling position is important particularly for tests with baskets as there can be a concentration profile between the bottom of the vessel and the stirring element. The sampling position is different for 500mL and 900mL tests. This can create problems for equipment that uses 'through the shaft' sampling.

Cannula Length — Cannula vary in length: 4.75" (120mm) is used for 900mL, 7.75" (195mm) is used for 500mL and extended lengths are normally used for "through the head sampling" whereby the cannula passes through the drive head of the dissolution bath.

Cannula Material — The cannula are made from either stainless steel or PEEK so that they do not absorb or interfere with the active ingredient.

Stoppers — Cannula can be used with stoppers during manual sampling to ensure that the sample is always taken from the same depth. Stoppers are attached to the cannula and sit in a hole in the vessel cover. If these are to be used then it is important to get the stopper and cannula to match the vessel cover type. The range of self-tightening stoppers can be installed and positioned without the need for tools such as screwdrivers. See below for more details.

SELECTING A SELF-TIGHTENING CANNULA STOPPER

Self-tightening cannula stoppers offer a convenient method of setting the cannula sampling position in accordance with USP 711.

Adjustable cannula stoppers are available for Distek, Hanson and Agilent/VanKel cannula.

Since there are numerous configurations of cannula and dissolution instruments in common use, the specific application should be reviewed to ensure correct stopper selection.

The two factors which determine the specific stopper choice are:

- 1) Cannula Outside Diameter (OD)
- 2) Stopper Outside Diameter (OD)

The part numbering system incorporates both cannula and stopper outside diameters.

Cannula OD Inches	Manufacturer	Stopper OD Inches	Manufacturer
.065 (1/16")	Distek/Hanson	.31	Agilent/VanKel
.078	Agilent/VanKel	.44	Hanson/Waters
.125 (1/8")	Hanson	.53	Distek
.142	Agilent/VanKel		

Part Numbering System:

CANSTP - 065 - 53

Cannula OD ——— Stopper OD

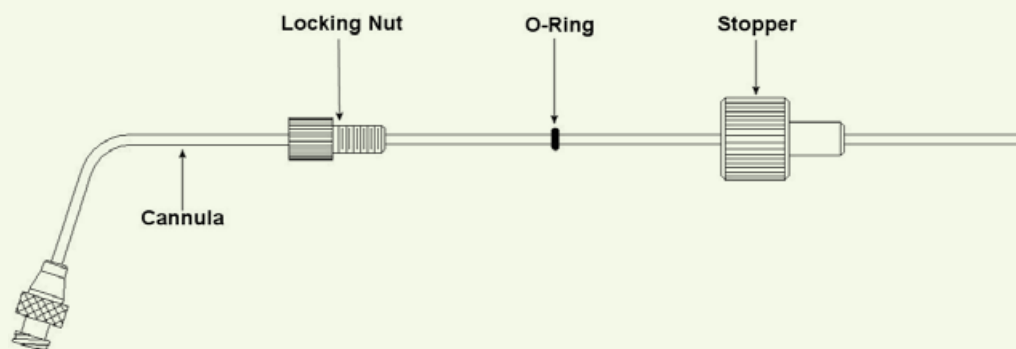

Stopper Configurations: Common configurations are listed with the appropriate cannula. Configurations not listed are available by special order. Email qlasales@qla-llc.com or contact your QLA Sales Representative.

Part No.	Description	OEM Ref
CAN475-01	4.75" (120mm) Bent 316 SS Cannula with SS Luer Lock & Tygon Tubing	12-3200
CAN775-01	7.75"(195mm) Bent 316 SS Cannula with SS Luer Lock & Tygon Tubing	12-3210
CAN475-VK	4.75" (120mm) Bent 316 SS Cannula with SS Luer Lock & Perm SS Tip	QLA
CAN775-VK	7.75" (195mm) Bent 316 SS Cannula with SS Luer Lock & Perm SS Tip	QLA
CA8475-VK	4.75" (120mm) Bent 316 SS 1/8" (3.2mm) OD Cannula with SS Luer Lock	QLA
CA8775-VK	7.75"(195mm) Bent 316 SS 1/8" (3.2mm) OD Cannula with SS Luer Lock	QLA
CA8015-VK	15" (380mm) Bent 316 SS 1/8" (3.2mm) OD Cannula with SS Luer Lock	QLA
CA8475-PV	4.75" (120mm) Bent PEEK 1/8" (3.2mm) OD Cannula with PEEK Luer Lock	QLA
CA8775-PV	7.75"(195mm) Bent PEEK 1/8" (3.2mm) OD Cannula with PEEK Luer Lock	QLA
CA8015-PV	15" (380mm) Bent PEEK 1/8" (3.2mm) OD Cannula with PEEK Luer Lock	QLA
CAN475-01L	4.75" (120mm) Bent 316 SS Cannula with Kynar Luer Lock & Tygon Tubing	QLA
CAN775-01L	7.75" (195mm) Bent 316 SS Cannula with Kynar Luer Lock & Tygon Tubing	QLA
CAN900-45	4.5" (115mm) Auto-Sampling Cannula for 900mL	17-3300
CAN500-60	6.5" (165mm) Auto-Sampling Cannula for 500mL	17-3305
CANRET-25	2.5" (65mm) Auto-Sampling Return Cannula	17-3320
PROBEX-VK	500mL Cannula Extension Kit	17-3306
CANSTP-078-31	VanKel Cannula Stopper for VanKel EaseAlign Cover	QLA
CANSTP-078-53	VanKel Cannula Stopper for Distek Cover	QLA
CANSTP-142-31	VanKel 1/8" (3.2mm) OD Cannula Stopper for VanKel EaseAlign Cover	QLA
CANSTP-142-53	VanKel 1/8" (3.2mm) OD Cannula Stopper for Distek Cover	QLA
CANSTP082-70XDS	Adjustable Stopper for Agilent 708/709-DS (.082 OD)	QLA
CANSTP125-70XDS	Adjustable Stopper for Agilent 708/709-DS (.125 OD)	QLA

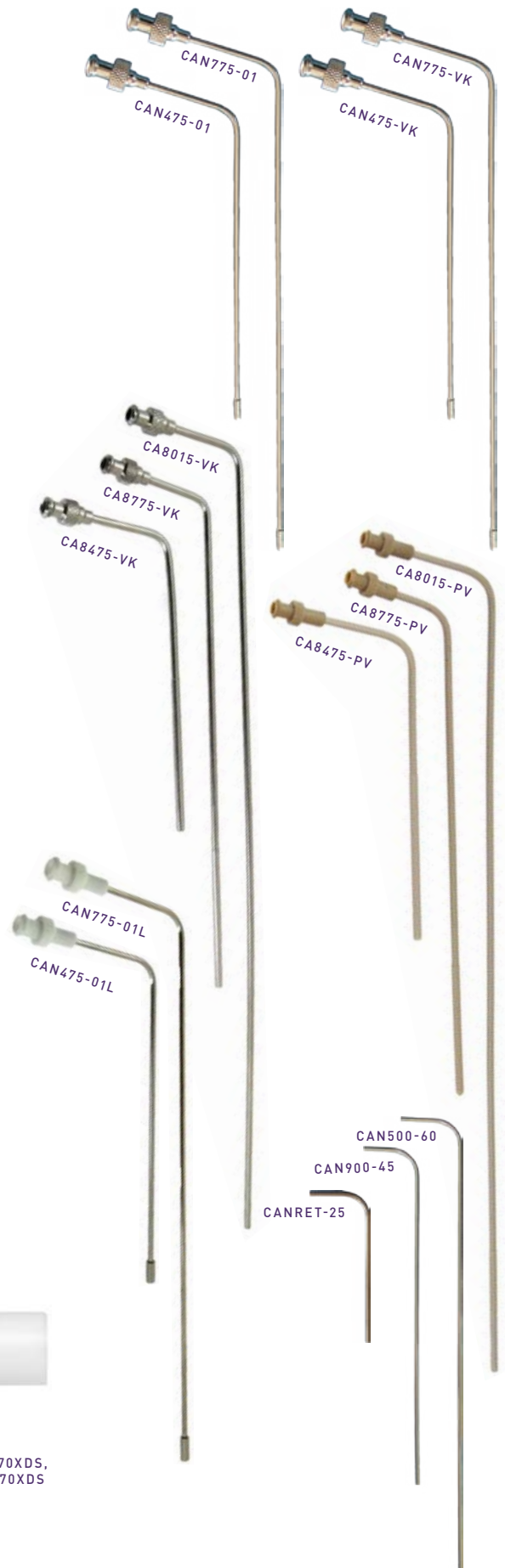

PROBEX-VK



CANSTP-078-31,
CANSTP-142-31



CANSTP-078-53,
CANSTP-142-53



CANSTP082-70XDS,
CANSTP125-70XDS

DISTEK COMPATIBLE SAMPLING CANNULA

See opposite page for Distek Sampling Probes.

Part No.	Description	OEM Ref
CAN500-DK	500mL Standard Sampling Probe	2910-0500
CAN900-DK	900mL Standard Sampling Probe	2910-0900
CAN01K-DK	1000mL Standard Sampling Probe	2910-1000
CAN02K-DK	2000mL Standard Sampling Probe	QLA
ORING-CANDK	Silicone O-Ring for DK Series Probe (Pack/12)	QLA
CAN500-DSH	500mL Sampling Probe, Solid Housing	2910-0506
CAN900-DSH	900mL Sampling Probe, Solid Housing	2910-0906
CAN01K-DSH	1000mL Sampling Probe, Solid Housing	2910-1006
FILASY-DK	Inline Filter Housing Assembly – Standard DK Series	QLA
FILASY-DV	Inline Filter Housing Assembly – DV Series	QLA
CANRET-DK	Return Probe, Distek	2910-0001
CANFAE-DK	Female Luer Adapter & Elbow Assembly	QLA
CANFLA-DK	Female Luer Adapter	5720-9059
CANFLE-DK	Male to Female Elbow	5720-9074
THD90-065	90 degree Cannula Elbow	QLA
CANSTP-065-31	Distek/Hanson 1/16" (1.6mm) OD Cannula Stopper for VanKel EaseAlign Cover	QLA
CANSTP-065-53	Distek/Hanson 1/16" (1.6mm) OD Cannula Stopper for Distek Cover	QLA



ERWEKA COMPATIBLE SAMPLING CANNULA

Part No.	Description	OEM Ref
CAN475-SH	4.75" (120mm) Bent 316 SS 1/8" (3.2mm) OD Cannula with SS Luer Lock	QLA
CAN775-SH	7.75" (195mm) Bent 316 SS 1/8" (3.2mm) OD Cannula with SS Luer Lock	QLA
CAN015-SH	15" (380mm) Bent 316 SS 1/8" (3.2mm) OD Cannula with SS Luer Lock	QLA
CAN475-PH	4.75" (120mm) Bent PEEK 1/8" (3.2mm) OD Cannula with PEEK Luer Lock	QLA
CAN775-PH	7.75" (195mm) Bent PEEK 1/8" (3.2mm) OD Cannula with PEEK Luer Lock	QLA
CAN015-PH	15" (380mm) Bent PEEK 1/8" (3.2mm) OD Cannula with PEEK Luer Lock	QLA
CANSTP-EW	Adjustable Cannula Stopper for Erweka	QLA



DV SERIES HIGH CAPACITY SAMPLING PROBES (PATENT# US 7,850,919 B2)

Increased capacity for most brands of dissolution baths.

Available for 500mL, 900mL and 1000mL tests, the DV Series style sampling probe has a twist-lock housing which safely contains a standard Full Flow Filter (Agilent / QLA "01" style). This means that the same cannula filters can be used for different dissolution baths offering increased flexibility. The surface area of the Full Flow Filter is 7 times greater than the small filter discs traditionally used in the standard style resident sampling probe. It is also much easier to remove the larger Full Flow Filter from the housing after use.

The Sampling Probe's thin low-volume stainless steel cannula can remain in the vessel throughout the dissolution test without affecting the dissolution result, removing the need for an automated cannula lift. The probe simply sits in the vessel cover and samples from the same position every time. It is the ideal solution for auto-samplers that use resident probes.

PROBE ASSEMBLY

Part No.	Description	OEM Ref
CAN500-DV	500mL DV Series Sampling Probe uses QLA "01" Filters	QLA
CAN900-DV	900mL DV Series Sampling Probe uses QLA "01" Filters	QLA
CAN01K-DV	1000mL DV Series Sampling Probe uses QLA "01" Filters	QLA
CAN02K-DV	2000mL DV Series Sampling Probe uses QLA "01" Filters	QLA
ORING-CANDV	Silicone O-Ring for DV Series Probe (Pack/12)	QLA

HIGH CAPACITY FILTERS

Part No.	Description	OEM Ref
FIL001-01	1 Micron Full Flow Filters, UHMW Polyethylene (Jar/1000)	QLA
FIL001-01-a	1 Micron Full Flow Filters, UHMW Polyethylene (Pack/100)	QLA
FIL002-01	2 Micron Full Flow Filters, UHMW Polyethylene (Jar/1000)	QLA
FIL002-01-a	2 Micron Full Flow Filters, UHMW Polyethylene (Pack/100)	QLA
FIL010-01	10 Micron Full Flow Filters, UHMW Polyethylene (Jar/1000)	17-4005
FIL010-01-a	10 Micron Full Flow Filters, UHMW Polyethylene (Pack/100)	17-4000
FIL020-01	20 Micron Full Flow Filters, UHMW Polyethylene (Jar/1000)	QLA
FIL020-01-a	20 Micron Full Flow Filters, UHMW Polyethylene (Pack/100)	QLA
FIL035-01	35 Micron Full Flow Filters, UHMW Polyethylene (Jar/1000)	17-4015
FIL035-01-a	35 Micron Full Flow Filters, UHMW Polyethylene (Pack/100)	17-4010
FIL045-01	45 Micron Full Flow Filters, UHMW Polyethylene (Jar/1000)	QLA
FIL045-01-a	45 Micron Full Flow Filters, UHMW Polyethylene (Pack/100)	QLA
FIL070-01	70 Micron Full Flow Filters, UHMW Polyethylene (Jar/1000)	17-4025
FIL070-01-a	70 Micron Full Flow Filters, UHMW Polyethylene (Pack/100)	17-4020

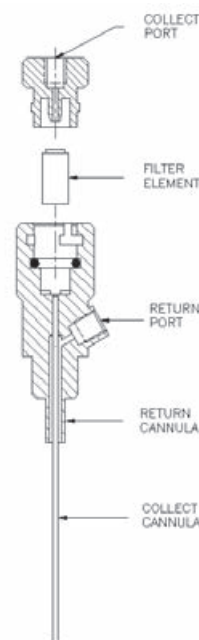

DUAL DV SERIES HIGH CAPACITY SAMPLING PROBES

These probes offer the same features and benefits as the DV Series probes described above but with the addition of a return port. The return port provides a "return to vessel" path for Dissolution Protocols which require samples to be returned or Protocols which require media replacement. Since both the collect and return ports are integrated into a single housing only one hole in the vessel cover is used.

Media Volume	Agilent/Vankel	Distek	Hanson
500mL	CAN500-DVV	CAN500-DDV	CAN500-DHV
900mL	CAN900-DVV	CAN900-DDV	CAN900-DHV
1000mL	CAN01K-DVV	CAN01K-DDV	CAN01K-DHV
2000mL	CAN02K-DVV	CAN02K-DDV	CAN02K-DHV

HANSON

COMPATIBLE SAMPLING CANNULA

Part No.	Description	OEM Ref
CAN475-HR	4.75" (120mm) Bent 316 SS Cannula with SS Luer Lock & Perm SS Tip	QLA
CAN775-HR	7.75" (195mm) Bent 316 SS Cannula with SS Luer Lock & Perm SS Tip	QLA
CAN475-SH	4.75" (120mm) Bent 316 SS 1/8" (3.2mm) OD Cannula with SS Luer Lock	95-590-002
CAN775-SH	7.75" (195mm) Bent 316 SS 1/8" (3.2mm) OD Cannula with SS Luer Lock	95-590-001
CAN015-SH	15" (380mm) Bent 316 SS 1/8" (3.2mm) OD Cannula with SS Luer Lock	95-590-003
CANS15-SH	15" (380mm) Straight 316 SS 1/8" (3.2mm) OD Cannula with SS Luer Lock	QLA
CAN475-PH	4.75" (120mm) Bent PEEK 1/8" (3.2mm) OD Cannula with PEEK Luer Lock	95-590-005
CAN775-PH	7.75" (195mm) Bent PEEK 1/8" (3.2mm) OD Cannula with PEEK Luer Lock	95-590-004
CAN015-PH	15" (380mm) Bent PEEK 1/8" (3.2mm) OD Cannula with PEEK Luer Lock	95-590-006
CANS15-PH	15" (380mm) Straight PEEK 1/8" (3.2mm) OD Cannula with PEEK Luer Lock	QLA
CAN475-SHL	4.75" (120mm) Bent 316 SS 1/8" (3.2mm) OD Cannula with Kynar Luer Lock	QLA
CAN775-SHL	7.75" (195mm) Bent 316 SS 1/8" (3.2mm) OD Cannula with Kynar Luer Lock	QLA
CAN475-062L	4.75" (120mm) Bent 316 SS 1/16" (1.6mm) OD Cannula with Kynar Luer Lock	QLA
CAN775-062L	7.75" (195mm) Bent 316 SS 1/16" (1.6mm) OD Cannula with Kynar Luer Lock	QLA
CANSTP-125-31	Hanson 1/8" (3.2mm) OD Cannula Stopper for VanKel EaseAlign Cover	QLA
CANSTP-125-53	Hanson 1/8" (3.2mm) OD Cannula Stopper for Distek Cover	QLA
CANSTP-065-31	Distek/Hanson 1/16" (1.6mm) OD Cannula Stopper for VanKel EaseAlign Cover	QLA
CANSTP-065-53	Distek/Hanson 1/16" (1.6mm) OD Cannula Stopper for Distek Cover	QLA
74-104-202	500mL Fixed Vessel Mount Sample Probe, 1/16" (1.6mm) OD for Vision	74-104-202
74-104-203	900mL Fixed Vessel Mount Sample Probe, 1/16" (1.6mm) OD for Vision	74-104-203
STPR-HR	Cannula Stopper for Vision	74-104-205



CANSTP-125-31,
CANSTP-065-31

CANSTP-125-53,
CANSTP-065-53

74-104-202

STPR-HR

PHARMATEST COMPATIBLE SAMPLING CANNULA

Part No.	Description	OEM Ref
CAN475-SH	4.75" (120mm) Bent 316 SS 1/8" (3.2mm) OD Cannula with SS Luer Lock	QLA
CAN775-SH	7.75" (195mm) Bent 316 SS 1/8" (3.2mm) OD Cannula with SS Luer Lock	QLA
CAN475-PH	4.75" (120mm) Bent PEEK 1/8" (3.2mm) OD Cannula with PEEK Luer Lock	QLA
CAN775-PH	7.75" (195mm) Bent PEEK 1/8" (3.2mm) OD Cannula with PEEK Luer Lock	QLA



SOTAX COMPATIBLE SAMPLING CANNULA

Part No.	Description	OEM Ref
CAN013-ST	13" (330mm) Bent 316 SS Cannula with SS Luer Lock (thru head mount)	QLA
CAN013-ST-5	13" (330mm) Bent 316 SS Cannula, Pre-set with stopper for 500mL	QLA
CAN013-ST-9	13" (330mm) Bent 316 SS Cannula, Pre-set with stopper for 900mL	QLA
CAN013-ST-5-9	13" (330mm) Bent 316 SS Cannula with 2 Position Stopper	QLA
PRBFSR-5S	500mL Sample/Return Probe Fixed w/ Filter Housing, Stopper & Up/Down Collars	QLA
PRBFSR-9S	900mL Sample/Return Probe Fixed w/ Filter Housing, Stopper & Up/Down Collars	QLA
PRBFSR-ST	Combined Sample/Return Cannula with Filter Housing	QLA
PRBNSR-ST	Combined Sample/Return Cannula without Filter Housing	QLA
PRBFS10-ST	500/900mL 316 SS Cannula with Inline Filter Housing (125 tubing) for AT/AT7smart	QLA
PRBFS10-ST82	500/900mL 316 SS Cannula with Inline Filter Housing (082 tubing) for AT/AT7smart	QLA
010-06-202	1" (25.4mm) gauge block to set stopper height for PRBFS10-ST & PRBFS10-ST82	QLA
CANSTP-ST	Adjustable Cannula Stopper for CAN013-ST	QLA



CANNULA FILTERS

THE CANNULA FILTER

Almost every dissolution test relies on samples being taken to produce a result. Filters are used to prevent particles of tablet from getting into the sample and affecting the spectrophotometer or HPLC results.

Filters should be shown not to absorb any compounds of interest.

All filters are U.S. Pharmacopeia compliant where applicable and meet machine manufacturer specifications.

GUARANTEED CHROMIUM AND HEAVY METAL FREE

Our PureQuality certification program guarantees our filters not to have any Chromium, heavy metals, material contaminants or inorganic elemental interference. These are the purest and highest quality filters available today.



KEY CONSIDERATIONS

Most manufacturers use a filter on the end of the sampling cannula. These cannula filters are made of Ultra High Molecular Weight (UHMW) Polyethylene and are completely inert to most compounds.

With filters, porosities are nominal and represent an average pore size rather than an absolute pore size. Thus a 35µm and 40µm filter will perform in much the same way.

If in-line filters are used it is important that a small amount of media is pushed back in the reverse direction to wash particles off the filter back into the vessel. Particles are part of the tablet and as such should be kept inside the vessel dissolving with the rest of the tablet.

Failure to do this results in the particles staying on the filter. The effect of this is not only to remove the particles from the media but next time a sample is taken, the media is pulled through the particles stuck to the filter which can give erroneously high readings.

When selecting a filter, it is wise to conduct some tests to ensure that there is no sample absorption onto the filter. If this is a problem then alternative filters and materials are available but external filtration may be required.

Types of Filters:

- **Cannula Filters** — Cannula Filters generally have a large surface area and may affect the hydrodynamics in the vessel. However they have a good flow rate and may be used when high levels of particulates are present to prevent particulates blocking the sample probes. A large porosity range is available. Different manufacturers recommend different filters for use with their sampling cannula and not all are interchangeable because of differences in cannula diameter.
- **Filter Discs** — Some low volume sample probes require an In-Line Filter Disc (or filter frit) which has a lower surface area than a cannula filter. These are designed to keep the filtration process outside the vessel but may suffer from blocking due to the lower surface area. These are designed to keep the filtration process outside the vessel but blockages may occur due to the lower surface area.
- **Filter Tips** — Filter Tips are smaller than cannula filters and fit on the end of larger diameter sample probes.



FULL FLOW FILTERS
AGILENT/VANKEL
AND DISTEK DV SERIES
AUTO-SAMPLER PROBES
(see page 31 and 35)



CANNULA FILTERS
(see All Manufacturers
pages 35 - 37)



FILTER TIPS
(see Agilent/VanKel page 35)



FILTER DISCS
(see Distek page 35)

AGILENT COMPATIBLE CANNULA FILTERS

(INCLUDES LEGACY VANKEL)

Agilent and Legacy VanKel baths normally use either cannula style full flow filters or filter tips. *With Direct Fit, no tygon tubing needed.

Part No.	Description	OEM Ref
FIL001-01	1 Micron Full Flow Filters, UHMW Polyethylene (Jar/1000)	QLA
FIL001-01-a	1 Micron Full Flow Filters, UHMW Polyethylene (Pack/100)	QLA
FIL002-01	2 Micron Full Flow Filters, UHMW Polyethylene (Jar/1000)	QLA
FIL002-01-a	2 Micron Full Flow Filters, UHMW Polyethylene (Pack/100)	QLA
FIL010-01	10 Micron Full Flow Filters, UHMW Polyethylene (Jar/1000)	17-4005
FIL010-01-a	10 Micron Full Flow Filters, UHMW Polyethylene (Pack/100)	17-4000
FIL010-VK	10 Micron Full Flow Filters, UHMW Polyethylene, Direct Fit* (Jar/1000)	QLA
FIL010-VK-a	10 Micron Full Flow Filters, UHMW Polyethylene, Direct Fit* (Pack/100)	QLA
FIL020-01	20 Micron Full Flow Filters, UHMW Polyethylene (Jar/1000)	QLA
FIL020-01-a	20 Micron Full Flow Filters, UHMW Polyethylene (Pack/100)	QLA
FIL035-01	35 Micron Full Flow Filters, UHMW Polyethylene (Jar/1000)	17-4015
FIL035-01-a	35 Micron Full Flow Filters, UHMW Polyethylene (Pack/100)	17-4010
FIL035-VK	35 Micron Full Flow Filters, UHMW Polyethylene, Direct Fit* (Jar/1000)	QLA
FIL035-VK-a	35 Micron Full Flow Filters, UHMW Polyethylene, Direct Fit* (Pack/100)	QLA
FIL045-01	45 Micron Full Flow Filters, UHMW Polyethylene (Jar/1000)	QLA
FIL045-01-a	45 Micron Full Flow Filters, UHMW Polyethylene (Pack/100)	QLA
FIL045-VK	45 Micron Full Flow Filters, UHMW Polyethylene, Direct Fit* (Jar/1000)	QLA
FIL045-VK-a	45 Micron Full Flow Filters, UHMW Polyethylene, Direct Fit* (Pack/100)	QLA
FIL070-01	70 Micron Full Flow Filters, UHMW Polyethylene (Jar/1000)	17-4025
FIL070-01-a	70 Micron Full Flow Filters, UHMW Polyethylene (Pack/100)	17-4020
FIL070-VK	70 Micron Full Flow Filters, UHMW Polyethylene, Direct Fit* (Jar/1000)	QLA
FIL070-VK-a	70 Micron Full Flow Filters, UHMW Polyethylene, Direct Fit* (Pack/100)	QLA
FILTIP-02	2 Micron Filter Tips (Jar/1000)	17-4100
FILTIP-05	5 Micron Filter Tips (Jar/1000)	17-4110
FILTIP-10	10 Micron Filter Tips (Jar/1000)	17-4120
FILTIP-20	20 Micron Filter Tips (Jar/1000)	17-4130
FILTIP-45	45 Micron Filter Tips (Jar/1000)	17-4140



AGILENT/VANKEL
CANNULA FILTERS



AGILENT/VANKEL
FILTER TIPS

Tygon Tubing Troubles? Go for a Direct Fit!

Try QLA's VK series Full Flow Filters. These filters have been designed to fit directly onto the end of the standard Agilent/VanKel style manual and automated cannula. No tygon tubing needed! Ask your QLA Sales Rep for more information.

DISTEK COMPATIBLE CANNULA FILTERS

Distek baths utilize a resident sampling probe that incorporates a small filter disc. An external end tip filter may also be used instead of, or in addition to the filter disc. For DV Series Auto-Sampler Probe Filters, see page 31.

Part No.	Description	OEM Ref
FIL010-DK	10 Micron Filter Discs, UHMW Polyethylene (Jar/1000)	5720-0203-1000
FIL010-DK-a	10 Micron Filter Discs, UHMW Polyethylene (Pack/100)	QLA
FIL035-DK	35 Micron Filter Discs, UHMW Polyethylene (Jar/1000)	5720-0235
FIL045-DK	45 Micron Filter Discs, UHMW Polyethylene (Jar/1000)	5720-0275-1000
FIL045-DK-a	45 Micron Filter Discs, UHMW Polyethylene (Pack/100)	QLA
FIL070-DK	70 Micron Filter Discs, UHMW Polyethylene (Jar/1000)	QLA
FIL070-DK-a	70 Micron Filter Discs, UHMW Polyethylene (Pack/100)	QLA
FIL090-DK	90 Micron Filter Discs, UHMW Polyethylene (Jar/1000)	QLA
FIL090-DK-a	90 Micron Filter Discs, UHMW Polyethylene (Pack/100)	QLA
FIL10S-DK	10 Micron Porous Filters, UHMW Polyethylene, 1/16" (Jar/1000)	5720-0501
FIL10S-DK-a	10 Micron Porous Filters, UHMW Polyethylene, 1/16" (Pack/100)	5720-0500
FIL20S-DK	20 Micron Porous Filters, UHMW Polyethylene, 1/16" (Jar/1000)	5720-0240-1000
FIL20S-DK-a	20 Micron Porous Filters, UHMW Polyethylene, 1/16" (Pack/100)	5720-0240-100
FIL35S-DK	35 Micron Porous Filters, UHMW Polyethylene, 1/16" (Jar/1000)	5720-0220-1000
FIL35S-DK-a	35 Micron Porous Filters, UHMW Polyethylene, 1/16" (Pack/100)	5720-0220-100
FIL45S-DK	45 Micron Porous Filters, UHMW Polyethylene, 1/16" (Jar/1000)	5720-0020-1000
FIL45S-DK-a	45 Micron Porous Filters, UHMW Polyethylene, 1/16" (Pack/100)	5720-0020-100
FIL70S-DK	70 Micron Porous Filters, UHMW Polyethylene, 1/16" (Jar/1000)	5720-0503
FIL70S-DK-a	70 Micron Porous Filters, UHMW Polyethylene, 1/16" (Pack/100)	5720-0502



DISTEK
FILTER DISCS



DISTEK
CANNULA FILTERS

ERWEKA COMPATIBLE CANNULA FILTERS

Erweka baths normally use 1/8" (3.2mm) cannula style filters with a large range of porosities.

Part No.	Description	OEM Ref
FIL001-EW	1 Micron Porous Filters, UHMW Polyethylene (Jar/1000)	70-000-2999
FIL001-EW-a	1 Micron Porous Filters, UHMW Polyethylene (Pack/100)	70-000-2100
FIL004-EW	4 Micron Porous Filters, UHMW Polyethylene (Jar/1000)	70-000-3999
FIL004-EW-a	4 Micron Porous Filters, UHMW Polyethylene (Pack/100)	70-000-3100
FIL010-EW	10 Micron Porous Filters, UHMW Polyethylene (Jar/1000)	70-000-4999
FIL010-EW-a	10 Micron Porous Filters, UHMW Polyethylene (Pack/100)	70-000-4100
FIL020-EW	20 Micron Porous Filters, UHMW Polyethylene (Jar/1000)	70-000-5999
FIL020-EW-a	20 Micron Porous Filters, UHMW Polyethylene (Pack/100)	70-000-5100
FIL035-EW	35 Micron Porous Filters, UHMW Polyethylene (Jar/1000)	QLA
FIL035-EW-a	35 Micron Porous Filters, UHMW Polyethylene (Pack/100)	QLA
FIL040-EW	40 Micron Porous Filters, UHMW Polyethylene (Jar/1000)	QLA
FIL040-EW-a	40 Micron Porous Filters, UHMW Polyethylene (Pack/100)	QLA
FIL070-EW	70 Micron Porous Filters, UHMW Polyethylene (Jar/1000)	QLA
FIL070-EW-a	70 Micron Porous Filters, UHMW Polyethylene (Pack/100)	QLA



ERWEKA
CANNULA FILTERS

HANSON COMPATIBLE CANNULA FILTERS

Hanson Research baths use cannula style filters. The Hanson/Waters Dissolution/HPLC interface uses a 1/16" (1.6mm) narrow bore filter instead of the normal 1/8" (3.2mm) diameter.

Part No.	Description	OEM Ref
FIL001-HR	1 Micron Porous Filters, UHMW Polyethylene (Jar/1000)	27-101-097
FIL001-HR-a	1 Micron Porous Filters, UHMW Polyethylene (Pack/100)	27-101-087
FIL004-HR	4 Micron Porous Filters, UHMW Polyethylene (Jar/1000)	27-101-098
FIL004-HR-a	4 Micron Porous Filters, UHMW Polyethylene (Pack/100)	27-101-088
FIL010-HR	10 Micron Porous Filters, UHMW Polyethylene (Jar/1000)	27-101-091
FIL010-HR-a	10 Micron Porous Filters, UHMW Polyethylene (Pack/100)	27-101-074
FIL020-HR	20 Micron Porous Filters, UHMW Polyethylene (Jar/1000)	QLA
FIL020-HR-a	20 Micron Porous Filters, UHMW Polyethylene (Pack/100)	QLA
FIL035-HR	35 Micron Porous Filters, UHMW Polyethylene (Jar/1000)	27-101-095
FIL035-HR-a	35 Micron Porous Filters, UHMW Polyethylene (Pack/100)	27-101-085
FIL045-HR	45 Micron Porous Filters, UHMW Polyethylene (Jar/1000)	QLA
FIL045-HR-a	45 Micron Porous Filters, UHMW Polyethylene (Pack/100)	27-101-089
FIL070-HR	70 Micron Porous Filters, UHMW Polyethylene (Jar/1000)	27-101-092
FIL070-HR-a	70 Micron Porous Filters, UHMW Polyethylene (Pack/100)	27-101-082
FIL10S-HR	10 Micron Porous Filters, UHMW Polyethylene, 1/16" (Jar/1000)	27-101-093
FIL10S-HR-a	10 Micron Porous Filters, UHMW Polyethylene, 1/16" (Pack/100)	27-101-083
FIL20S-HR	20 Micron Porous Filters, UHMW Polyethylene, 1/16" (Jar/1000)	QLA
FIL20S-HR-a	20 Micron Porous Filters, UHMW Polyethylene, 1/16" (Pack/100)	QLA
FIL35S-HR	35 Micron Porous Filters, UHMW Polyethylene, 1/16" (Jar/1000)	27-101-096
FIL35S-HR-a	35 Micron Porous Filters, UHMW Polyethylene, 1/16" (Pack/100)	27-101-086
FIL45S-HR	45 Micron Porous Filters, UHMW Polyethylene, 1/16" (Jar/1000)	QLA
FIL45S-HR-a	45 Micron Porous Filters, UHMW Polyethylene, 1/16" (Pack/100)	27-101-090
FIL70S-HR	70 Micron Porous Filters, UHMW Polyethylene, 1/16" (Jar/1000)	27-101-094
FIL70S-HR-a	70 Micron Porous Filters, UHMW Polyethylene, 1/16" (Pack/100)	27-101-084



HANSON
CANNULA FILTERS

PHARMATEST COMPATIBLE CANNULA FILTERS

Pharmatest baths normally use 1/8" (3.2mm) cannula style filters with a large range of porosities.

Part No.	Description	OEM Ref
FIL001-PT	1 Micron Porous Filters, UHMW Polyethylene (Jar/1000)	QLA
FIL001-PT-a	1 Micron Porous Filters, UHMW Polyethylene (Pack/100)	QLA
FIL004-PT	4 Micron Porous Filters, UHMW Polyethylene (Jar/1000)	QLA
FIL004-PT-a	4 Micron Porous Filters, UHMW Polyethylene (Pack/100)	QLA
FIL005-PT	5 Micron Porous Filters, UHMW Polyethylene (Jar/1000)	QLA
FIL005-PT-a	5 Micron Porous Filters, UHMW Polyethylene (Pack/100)	31-63511-50
FIL010-PT	10 Micron Porous Filters, UHMW Polyethylene (Jar/1000)	QLA
FIL010-PT-a	10 Micron Porous Filters, UHMW Polyethylene (Pack/100)	31-63211-50
FIL035-PT	35 Micron Porous Filters, UHMW Polyethylene (Jar/1000)	QLA
FIL035-PT-a	35 Micron Porous Filters, UHMW Polyethylene (Pack/100)	QLA
FIL070-PT	70 Micron Porous Filters, UHMW Polyethylene (Jar/1000)	QLA
FIL070-PT-a	70 Micron Porous Filters, UHMW Polyethylene (Pack/100)	QLA



**PHARMATEST
CANNULA FILTERS**

SOTAX COMPATIBLE CANNULA FILTERS

Sotax baths normally use 1/8" (3.2mm) cannula style filters with a large range of porosities.

Part No.	Description	OEM Ref
FIL010-ST	10 Micron Porous Filters, UHMW Polyethylene (Jar/1000)	27-101-091
FIL010-ST-a	10 Micron Porous Filters, UHMW Polyethylene (Pack/100)	27-101-074
FIL020-ST	20 Micron Porous Filters, UHMW Polyethylene (Jar/1000)	QLA
FIL020-ST-a	20 Micron Porous Filters, UHMW Polyethylene (Pack/100)	QLA
FIL035-ST	35 Micron Porous Filters, UHMW Polyethylene (Jar/1000)	27-101-095
FIL035-ST-a	35 Micron Porous Filters, UHMW Polyethylene (Pack/100)	27-101-085
FIL070-ST	70 Micron Porous Filters, UHMW Polyethylene (Jar/1000)	27-101-092
FIL070-ST-a	70 Micron Porous Filters, UHMW Polyethylene (Pack/100)	27-101-082



**SOTAX
CANNULA FILTERS**

CANNULA FILTERS COLOR CODING

Some cannula filters are color coded for easy identification of porosity.



TRANSDERMAL TESTING

PADDLE OVER DISK Apparatus 5

With paddle over disk, a transdermal patch is placed either between a glass disk and an inert PTFE mesh (APPFIVE-HR), or directly onto a stainless steel mesh (APPFIVE-V35, APPFIVE-V56 and APPFIVE-V80). This is placed at the bottom of the vessel, with the release side facing upwards, under a rotating paddle.

Transdermal testing is carried out at 32°C to reflect the temperature of the skin.

Other variables such as the height setting and sampling requirements are the same as for USP Method 2.

QLA's USP Apparatus 5 products are compatible with all brands of dissolution baths.

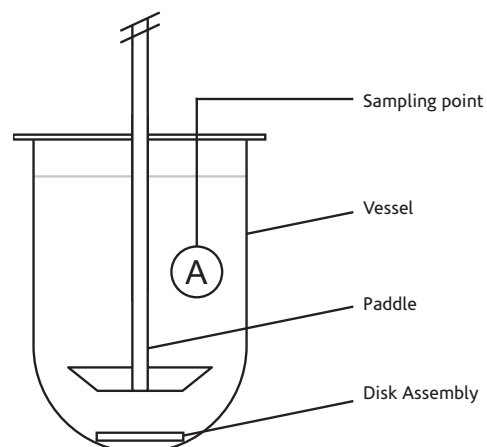

KEY CONSIDERATIONS

The APPFIVE-HR watch glass patch holder is a borosilicate watch glass with a 17 mesh PTFE screen, held together by Kynar clips. Patches up to 90mm in diameter can be tested. It is compatible with all brands of dissolution baths and conforms exactly to the USP specification.

The APPFIVE-V35, APPFIVE-V56 and APPFIVE-V80 patch holders have stainless steel screens and can accommodate various patch sizes. Various mesh sizes are available.

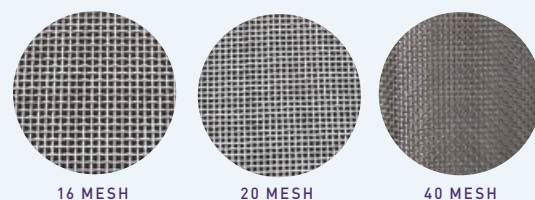

Note: Other mesh sizes are available on request. For more information, contact your QLA Sales Rep.

PADDLE OVER DISK APPARATUS 5

Part No.	Description	OEM Ref
APPFIVE-HR	Transdermal Patch Holder includes watch glass, (1) 17 mesh screen, (4) Kynar Clips	65-190-092 H
APPFIVE-HRCLIP	Kynar Clip for APPFIVE-HR	65-190-205 H
APPFIVE-HRSCR	17 mesh screen for APPFIVE-HR	65-190-190 H
APPFIVE-V35	Paddle over Disk Assembly, 35mm opening, 40 mesh screen, 316 SS	12-4200 A
APPFIVE-V56	Paddle over Disk Assembly, 56mm opening, 120 mesh screen, 316 SS	12-4230 A
APPFIVE-V80	Paddle over Disk Assembly, 80mm opening, (2) 16x16 mesh screens, 316 SS	QLA
APP5S16-35	16 Mesh Stainless Steel Screen for APPFIVE-V35 (Pack/25)	QLA
APP5S20-35	20 Mesh Stainless Steel Screen for APPFIVE-V35 (Pack/25)	QLA
APP5S30-35	30 Mesh Stainless Steel Screen for APPFIVE-V35 (Pack/25)	QLA
APP5S40-35	40 Mesh Stainless Steel Screen for APPFIVE-V35 (Pack/25)	QLA
APP5S20-56	20 Mesh Stainless Steel Screen for APPFIVE-V56 (Pack/25)	QLA
APP5S40-56	40 Mesh Stainless Steel Screen for APPFIVE-V56 (Pack/25)	QLA
APP5S120-56	120 Mesh Stainless Steel Screen for APPFIVE-V56 (Pack/25)	QLA
APP5S16-80	16 Mesh Stainless Steel Screen for APPFIVE-V80 (Pack/25)	QLA
TRANDE-SC	Custom Transdermal Screen, 316 SS	QLA



OEM Key

- A** AGILENT
- D** DISTEK
- H** HANSON

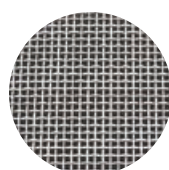

APP5S16-35

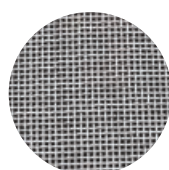

APP5S20-35

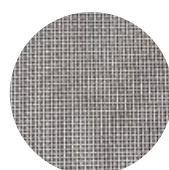

APP5S30-35

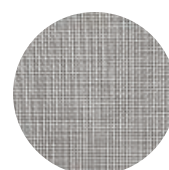

APP5S40-35



TRANDE-SC

ROTATING CYLINDER Apparatus 6

USP Apparatus 6 rotating cylinder is similar to USP Method 1 (the rotating basket). However, the basket assembly is replaced by a solid 316 Stainless Steel cylinder.

The transdermal patch is fixed to the outside surface of the cylinder.

Transdermal testing is carried out at 32°C to reflect the temperature of the skin.

Other variables such as the height setting and sampling requirements are the same as for USP Apparatus 1.

QLA's Rotating Cylinders and Extensions are serialized, come with a Certificate of Conformance and are compatible with most brands of dissolution baths.

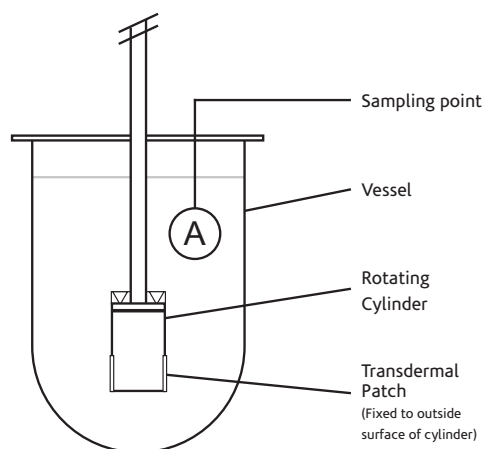
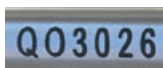

KEY CONSIDERATIONS

If an extension (APPSIX-EX) is needed, it should be ordered at the same time as the main cylinder (APPSIX-01/AP6CYL-DK/SPNAP6-01).

Other shaft lengths are available on request.



ROTATING CYLINDER ASSEMBLED WITH EXTENSION

ROTATING CYLINDER APPARATUS 6

Part No.	Description	OEM Ref
APPSIX-01	Rotating Cylinder for Transdermal Patches, 316 SS, Serialized	QLA
AP6CYL-DK	Detachable Rotating Cylinder for Transdermal Patches for Distek, 316 SS, Serialized	3200-0142 D
SPNAP6-01	Spin ON/OFF Rotating Cylinder for Transdermal Patches, 316 SS, Serialized (Upper Shaft available separately)	QLA
APPSIX-EX	Rotating Cylinder Extension for APPSIX-01/AP6CYL-DK/SPNAP6-01, 316 SS, Serialized	QLA
74-105-240	Rotating Cylinder for Transdermal Patches for Hanson Vision, 316 SS, Serialized	74-105-240 H
74-105-241	Rotating Cylinder and Extension Set for Hanson Vision, 316 SS, Serialized	74-105-241 H



APPSIX-01



APPSIX-EX



ROTATING CYLINDER VIEWED FROM BELOW

OEM Key

- A** AGILENT
- D** DISTEK
- H** HANSON



QLA's Laser Marking Capabilities are Endless!

Please contact us for any custom identification needs you may have.

BIODISSOLUTION ACCESSORIES

BIODISSOLUTION ACCESSORIES Apparatus 3

AGILENT COMPATIBLE BIODISSOLUTION ACCESSORIES
(INCLUDES LEGACY VANKEL)

Part No.	Description	OEM Ref
GLA100-VBIO	100mL Outer Glass, Clear, Non-Graduated	27-5110
GLA300-01	300mL Outer Glass, Clear, Non-Graduated	27-5100
GLA300-02	300mL Outer Glass, Clear, Graduated	QLA
GLA300-03	300mL Outer Glass, Clear with Class A 250mL mark	QLA
GLA300-AV	300mL Outer Glass, Amber, Non-Graduated	QLA
EVACOV-05	Evaporation Cover for 300mL Outer Glass, PVC	27-1500
GLAIST-01	100mL Glass Inner Sample Tube with threaded ends, Clear	27-5000
GLAIST-AV	100mL Glass Inner Sample Tube with threaded ends, Amber	QLA
LOWCAP-03	Lower Cap for 100mL Inner Sample Tube	27-1020
LOWCAP-05	Lower Cap for 100mL Inner Sample Tube, Wider Style for improved mixing	27-1050
UPPCAP-03	Upper Cap for 100mL Inner Sample Tube	27-1000
MSHSCR-10	10 Mesh Screen, Stainless Steel, 1.25" dia. (Pack/25)	27-2099
MSHSCR-20	20 Mesh Screen, Stainless Steel, 1.25" dia. (Pack/25)	27-2100
MSHSCR-30	30 Mesh Screen, Stainless Steel, 1.25" dia. (Pack/25)	27-2103
MSHSCR-40	40 Mesh Screen, Stainless Steel, 1.25" dia. (Pack/25)	27-2105
POLSCR-20	20 Mesh Screen, Polypropylene, 1.25" dia. (Pack/25)	27-2000
POLSCR-30	30 Mesh Screen, Polypropylene, 1.25" dia. (Pack/25)	QLA
POLSCR-40	40 Mesh Screen, Polypropylene, 1.25" dia. (Pack/25)	27-2005
POLSCR-78	78 Mesh Screen, Polypropylene, 1.25" dia. (Pack/25)	27-2010
POLSCR-1K	100 Mesh Screen, Polypropylene, 1.25" dia. (Pack/25)	27-2015
VESSTD-APP3/14	14 Position Vessel Stand for 300mL Outer Glass	QLA
VESSTD-APP3/20	20 Position Vessel Stand for 300mL Outer Glass	QLA



GLA100-VBIO GLA300-AV

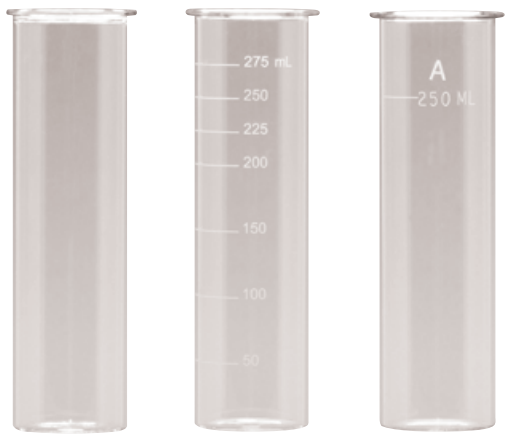

GLA300-01 GLA300-02 GLA300-03



EVACOV-05 LOWCAP-03 LOWCAP-05 UPPCAP-03



GLAIST-01 GLAIST-AV



MSHSCR-20 MSHSCR-30 MSHSCR-40 POLSCR-20 POLSCR-30 POLSCR-40 POLSCR-1K

CALIBRATION TOOLS

CONTROLLING HARDWARE VARIABLES

It is important to ensure the dissolution bath is working as intended, and giving precise and reproducible results. To do this it is important that the bath meets the USP or ASTM physical specification. The ASTM variables are tighter as they rely only on the physical measurement whereas the USP also requires a test using calibrator tablets.

KEY CONSIDERATIONS

The variables are:

Specification	ASTM	USP
Shaft Wobble	1.0mm Max.	No significant wobble
Shaft Verticality	Must be vertical, bubble within the lines	Not defined
Basket Wobble	1.0mm Max. at bottom rim	1.0mm Max. at bottom rim
Vessel Centering	1.0mm Max.	2.0mm Max.
Paddle/Basket Height	+/- 8% or +/- 2.0mm	+/- 2.0mm
Rotation	2% or +/- 2 rpm	+/- 4%
Temperature	+/- 0.5°C	+/- 0.5°C
Vibration	No significant vibration	No significant vibration
Vessel verticality	1° from vertical Max.	Not specified

QLA provides a comprehensive set of validation tools to measure these variables. All tools (except the verticality meter) are serialized and supplied with a traceable 1 year certificate of calibration.

Wobble Meter (WOBMET-UN) — The Wobble Meter uses a special vessel cover that fits securely inside the top of the vessel. The gauge is firmly attached to this cover then placed against the shaft or basket. The shaft is then rotated at a slow speed and the wobble (displacement) is displayed on the easy to read dial. The gauge works with all open dissolution baths (where you can access the vessel during the test).

Vibration Meter (VIBMET-UN) — This simple Vibration Meter allows you to quickly assess vibration levels and ensure that low levels are maintained when new equipment is introduced into the lab or after routine bath maintenance. It uses digital electronics but is equipped with an analog needle display. For this type of device, an analog display is better than a digital one because it gives a much better feel for the nature of the vibrations.

The meter uses an accelerometer probe that is calibrated to the meter as a matched set. The probe end has a custom mounting block that is compatible with most dissolution instruments.

Universal Level (LEVEL-UN) — The bath's vessel plate must be level to ensure the bath has been properly set up. Baths are equipped with adjustable feet which may be adjusted while observing the Universal Level to achieve vessel plate levelness. The certified level is a simple circular, bubble level that allows quick and easy verification of the vessel plate level in all directions at once.

Verticality Meter (VERTMET-MI) — This digital Verticality Meter is a highly precise device which permits accurate measurement of shaft and vessel verticality as required by the ASTM Specification. The meter is suitable for any open dissolution bath where vessels and shafts are accessible. The meter requires a simple user calibration at each time of use and for this reason is not supplied with a certificate of calibration (Available on request only).

Depth Setting Tools (DEPSET-25, DEPSET-25A, DEPSET-MI, DEPSET-VK, ASTMBALL-25, DEPSET-45, DEPSET-PK, DEPSET-SB) — QLA offers multiple tools for setting the height of the basket/paddle (use DDAPT-Plus to measure the height). See descriptions and pictures to identify which style will best suit the needs of your laboratory. To set the correct depth, simply place the gauge at the bottom of the vessel, lower the basket or paddle until it touches the spacer and lock the shaft into position.

Depth Measuring Gauges, Digital Depth Gauge (DDAPT-Plus) — The new Digital Depth Gauge is an extremely precise instrument used to accurately measure the basket/paddle distance from the vessel spherical bottom. This allows basket or paddle height to be determined within .01mm. The DDAPT-Plus Digital Depth Gauge is made to fit most open access dissolution baths.

Optical Tachometer (TACHOM-UN) — The most accurate method of measuring the rotational speed is by using an Optical Tachometer. A reflective sticker is placed on the shaft or shaft drive, the Optical Tachometer shines an infrared light on to the shaft at this point. The reflection is then measured at every rotation, giving an accurate reading of the rotational speed. The tachometer can be used on all dissolution baths.

Centering Gauge (CNTGAG-MI) — The Centering Gauge comes with a 3/8" OD surrogate shaft that fits directly into the shaft drive. A 10mm OD surrogate shaft (EUROINDC-M) is also available separately. The gauge may be placed near the vessel top and bottom (beginning of the spherical radius). This allows the impact of vessel verticality on centering to be evaluated. The spindle is rotated slowly and the measuring arm follows the inside of the vessel perimeter. Deviation from the center position can be directly read from the dial, which always faces the operator.

The gauge works on most open access baths. For bathless systems where the shaft cannot be easily removed, the gauge fits directly onto the bottom of the shaft once the basket hub or paddle is removed.

Calibrated Thermometer (THERMD-LC) — The digital Calibrated Thermometer is an extremely accurate thermistor-based low cost thermometer. It is ideal for validating dissolution bath and media temperature as well as general lab use. A simple switch lets you set the digital display to show either Celsius or Fahrenheit readings. The thermometer is supplied with a certificate of calibration.

Validation Tool Kits (VALTOL-KT2 & VALTOL-ASTM) — Our Validation Tool Kits contain everything necessary to make a complete calibration of a dissolution bath.

- The VALTOL-KT2 standard tool kit contains a Centering Gauge, Precision Level, Wobble Meter, Go/No Go Gauge (this is used to verify that the height is more than 23mm but less than 27mm) and a 25mm Depth Set Tool.
- The VALTOL-ASTM Tool Kit is the same as the KT2 kit but also includes the verticality meter and manual verticality tools.

Both kits contain instruction manuals, together with individual certificates of calibration.

Part No.	Description	OEM Ref
CNTGAG-MI	Vessel Centering Gauge, Multi-Instrument	QLA
EUROINDC-M	10mm Shaft for CNTGAG-MI	QLA
WOBMET-MI	Wobble Meter, Multi-Instrument	QLA
DDAPT-PLUS	25mm Digital Depth Gauge with Case, Multi-Instrument	QLA
ASTMBALL-25	25mm Calibrated Ball	QLA
DEPSET-25	25mm Depth Set Tool, Black Acrylic	QLA
DEPSET-25A	25mm Depth Set Tool, Carbon Fiber	QLA
DEPSET-MI	25mm Ball Style Depth Set Tool	QLA
DEPGAG-VK	25mm Depth Set Gauge, Stainless Steel, VanKel Style	12-7300 A
GNGDEP	Go/No Go 25mm Depth Gauge	QLA
DEPSET-45	45mm Ball Style Depth Set Tool	QLA
DEPSET-PK	Depth Set Tool for PEAK Vessels	QLA
DPSPBK-VK	25mm Basket Height Spacer for Legacy VanKel Baths	12-7210 A
DPSPPD-VK	25mm Paddle Height Spacer for Legacy VanKel Baths	12-7200 A
DEPSET-SB	1cm Stationary Basket Spacer for Legacy VanKel Baths	QLA
LEVEL-UN	Universal Precision Bubble Level, Multi-Instrument	QLA
VERTMET-MI	Digital Verticality Meter, Multi-Instrument	QLA
THERMD-LC	Calibrated Digital Thermometer, Multi-Instrument	QLA
TACHOM-UN	Optical Tachometer, Multi-Instrument	QLA
TACHCLIP	Tacometer Target Clip for 3/8" OD Shaft	QLA
VIBMET-UN	Vibration Meter includes probe and case, Multi-Instrument	QLA
VALTOL-ASTM	ASTM Validation Tool Kit includes Centering Gauge, Wobble Meter, 25mm Depth Set Tool, Go/No Go Gauge, Adapters, Digital Verticality Meter and Manual Verticality Tools (Not for use on Hanson Vision or Sotax)	QLA
VALTOL-KT2	Standard Validation Tool Kit includes Centering Gauge, Wobble Meter, 25mm Depth Set Tool, Go/No Go Gauge, Adapters and Precision Bubble Level (Not for use on Hanson Vision or Sotax)	QLA



MISC DISSOLUTION ACCESSORIES

VESSEL CENTERING SYSTEM ACCESSORIES

Problems with vessel centering? We have THE solution for that!

The QLA AccuCenter™ Bracket provides ultimate centering accuracy on most dissolution instruments (both old and new).

- Cost effective replacement for OEM centering systems
- Spring loaded, rotary knobs secure the vessel firmly in place and eliminate floating when empty

This innovative bracket is adjustable and designed to center the vessel from the inside diameter and not the outside. When used in conjunction with QLA's UltraCenter™ Precision Vessels, extreme centering accuracy can be achieved. Many older baths were not designed to meet the new tighter centering requirements of Enhanced Mechanical Calibration and/or ASTM. When Pharmaceutical Labs adopt these stricter mechanical guidelines, there is no need to run USP calibrator tablets! This generally results in considerable cost and time savings for your lab. Please speak with your QLA Sales Rep for more information.



ACCUCENTER BRACKET



EZLBKT-01

OEM Key

- A** AGILENT
- D** DISTEK



EZLPEG-01



RING01-DK



RING-UCEW

Part No.	Description	OEM Ref
ACCUBKT-VK	AccuCenter Bracket for Legacy VanKel and Agilent 708-DS Baths	QLA
EZLBKT-01	Vessel Centering Bracket with 6 Replaceable Pins for Legacy VanKel Baths	12-6050 A
EZLKIT-01	Vessel Centering Bracket Repair Kit (Set/12 Pins)	QLA
EZLPEG-01	Vessel Centering Bracket Peg	12-6065 A
ACCUBKT-DK	AccuCenter Bracket for Distek 2100 Baths	QLA
ACCUBKT-DK2500	AccuCenter Bracket for Distek 2500 Baths	QLA
ACCUBKT-IKIT2500	AccuCenter Bracket Installation Kit for Distek 2500 Baths	QLA
RING01-DK	Acculign Vessel Centering Ring for Distek	3350-0096 D
RING-UCEW	Vessel Hold Down Ring for UltraCenter Vessels on Erweka DT Baths	QLA
ACCUBKT-HR	AccuCenter Bracket for Hanson SR8-Plus Baths	QLA

AGILENT VK8000 AUTO-SAMPLER ACCESSORIES

Part No.	Description	OEM Ref
RINSETRAY6	6 Position Acrylic Rinse Tray	17-1300
RINSETRAY8	8 Position Acrylic Rinse Tray	17-1310
REPNEP-VL	Long Replacement Needle for VK8000	17-6100
REPNEP-VS	Short Replacement Needle for VK8000	17-6110



RINSETRAY8



REPNEP-VL

REPNEP-VS

WATER BATH PRESERVATIVE

Got Green Water? Try EVER-CLEAR

- Highly soluble water preservative crystals.
- Extremely effective against the formation of bacteria and fungi.
- Non-hazardous and its environmentally friendly formula does not require any special disposal instructions.
- Regular use will reduce the effect of microorganism build-up inside the bath and within the pump and heater.
- Use with DEIONIZED water.
- Single dose will protect a bath for up to 8 weeks.
- Time saving! No need to empty the bath while using Ever-Clear; just add one container to your bath every 8 weeks.



Part No.	Description	OEM Ref
EVERCLEAR	Ever-Clear Dissolution Bath Algaecide, Single Dose	QLA
EVERCLEAR-12	Ever-Clear Dissolution Bath Algaecide, Single Dose (Pack/12)	QLA
EVERCLEAR-48	Ever-Clear Dissolution Bath Algaecide, Single Dose (Pack/48)	QLA

TUBING

Part No.	Description	OEM Ref
PPTUBV-01	Peristaltic Pump Tubing, Santoprene, Coded Purple & White (Set/8)	17-6000 A
PPTUBV-02	Peristaltic Pump Tubing, Silicone, Coded Purple & White (Set/8)	17-6010 A
PPTUBD-01	Peristaltic Pump Tubing, Santoprene (Set/6)	5640-0337 D
TAATUB-HP	3 Collar Auto Analyzer Tubing, Tygon, .081" (2.06mm) ID (Set/12)	QLA
TEFTUB-HP	FEP Tubing for HP, PTFE, 1/32" (.8mm) ID x 1/16" (1.6mm) OD (500' (152m) Roll)	QLA
TEFTUB-8V	Color-Coded Sample Tubing, PTFE, .040" (1.02mm) ID x .066" (1.68mm) OD [8 Lengths of 50' (15m)]	QLA
TUBING	Tygon Tubing, 1/16" (1.6mm) ID x 1/8" (3.2mm) OD (Sold by Foot)	QLA
CANFER-UN	Flangeless Ferrule for 1/16" (1.6mm) Tubing	QLA
CANFLN-UN	Flangeless Nut, 1/4-28 for 1/16" (1.6mm) Tubing	QLA



PPTUBV-01



PPTUBV-02



PPTUBD-01



TAATUB-HP



TEFTUB-HP



TUBING

OEM Key

- A** AGILENT
- D** DISTEK



CANFER-UN



CANFLN-UN



TEFTUB-8V

PAPER ROLLS FOR AGILENT (INCLUDES LEGACY VANKEL)

Part No.	Description	OEM Ref
PAP100-01	Plain Paper Rolls for Report Center II (Pack/25)	12-9995
TPP082-70XDS	Thermal Paper Rolls, 2.25" wide (Pack/25)	12-9988
TPP100-01	Thermal Paper Rolls, 1.5" wide (Pack/25)	12-9994



PAP100-01



TPP100-01

SHAFT COLLARS

Part No.	Description	OEM Ref
TUMSCR-DK	Shaft Collar w/Thumb Screw for Distek 2100 Series	2821-0094 D
SHTCOL-DK	Shaft Collar & Hex Key for 3/8" OD Shaft	5570-6077 D
SHTCOL-EW	Locking collar for 10mm OD Shaft	QLA



TUMSCR-DK



SHTCOL-DK

PTFE SUSPENSION CUPS

Part No.	Description	OEM Ref
SUSPC-BASE	Weighted Holder, 57.2mm OD, 5.2mm ID.	12-4050 A
SUSPC-17.5	Insert cup, 17.5 x 8.2mm, use with SUSPC-BASE	12-4055 A
SUSPC-20	Insert cup, 20 x 8.2mm, use with SUSPC-BASE	12-4060 A



SUSPC-17.5



SUSPC-20



SUSPC-BASE



Do You Have Calibration, Maintenance or Repair Needs?

QLA Lab Services division will keep your lab equipment in optimal working order and is also ISO/IEC 17025 accredited. We provide calibration (PVT & EMC), validation, maintenance, repair, training, relocation, consulting and auditing services.

For more information visit www.QLAlabservices.com or call (908) 685-7500.

GLASS ACCESSORIES

VOLUMETRIC FLASKS

Part No.	Description	OEM Ref
VOLFLK-05	500mL Volumetric Flask, Class A, Calibrated at 20°C, Round Bottom	QLA
VOLFLK-09	900mL Volumetric Flask, Class A, Calibrated at 20°C, Round Bottom	QLA
VOLFLK-1K	1000mL Volumetric Flask, Class A, Calibrated at 20°C, Round Bottom	QLA
VOLFLK-X5	500mL Volumetric Flask, Class A, Calibrated at 37°C, Round Bottom	QLA
VOLFLK-X9	900mL Volumetric Flask, Class A, Calibrated at 37°C, Round Bottom	QLA
VOLFLK-X1	1000mL Volumetric Flask, Class A, Calibrated at 37°C, Round Bottom	QLA



500ML FLASK

900ML FLASK

1000ML FLASK

TAPPED DENSITY

Part No.	Description	OEM Ref
GLA010-01	10mL Graduated Cylinder, Funnel Top, Hexagonal Base	52-5000 A
GLA100-01	100mL Graduated Cylinder, Funnel Top, Hexagonal Base	52-5010 A
GLA1CA-01	100mL Graduated Cylinder, Funnel Top, Hexagonal Base, Class A, Calibrated at 20°C	QLA
GLA250-01	250mL Graduated Cylinder, Funnel Top, Hexagonal Base	52-5020 A



GLA010-01

GLA100-01

GLA1CA-01

GLA250-01

ROTATING BOTTLE APPARATUS FOR AGILENT

(INCLUDES LEGACY VANKEL)

Part No.	Description	OEM Ref
RBAASSY-01	100mL Clear Glass Bottle and Cap with Viton Liner	QLA
RBAASSY-02	100mL Clear Glass Bottle and Decant Cap with 40 Mesh SS Screen	QLA
RBSCRN-40	40 Mesh SS Screen for 100mL Decant Cap	32-1221 A



RBAASSY-01

RBAASSY-02

RBSCRN-40

MISC GLASS ACCESSORIES

Part No.	Description	OEM Ref
FLEAK-150	150mL Glass Fleaker, Graduated	QLA
FLEAK-300	300mL Glass Fleaker, Graduated	QLA
FLEAK-500	500mL Glass Fleaker, Graduated	QLA
FLEAK-01K	1000mL Glass Fleaker, Graduated	QLA
FLEAKCAP-UN	Fleaker Cap fits 150mL, 300mL and 500mL fleakers	QLA



FLEAK-150

FLEAK-300

FLEAK-500

FLEAK-01K



FLEAKCAP-UN

OEM Key

A AGILENT

DISINTEGRATION TESTING

AGILENT

COMPATIBLE
(INCLUDES LEGACY VANKEL)

Part No.	Description	OEM Ref
DISASY-03	Basket Assembly with 3 Glass Tubes and 10 Mesh Stainless Steel Screens	37-3030
DISASY-06	Basket Assembly with 6 Glass Tubes and 10 Mesh Stainless Steel Screens	37-2001
DISASY-P6	Basket Assembly with 6 Plastic Tubes and 10 Mesh Stainless Steel Screens	QLA
DISTUB-06	Glass Replacement Tubes for 6 Tube Assembly, 25mm (Set/6)	37-5000
DISTUB-P6	Plastic Replacement Tubes for 6 Tube Assembly, 25mm (Set/6)	QLA
DISTUB-03	Glass Replacement Tubes for 3 Tube Assembly, 38mm (Set/3)	37-5005
FDISC-VK	USP Fluted Plastic Disks for 6 Tube Assembly (Set/6)	37-4000
DISDISK-03	USP Fluted Plastic Disks for 3 Tube Assembly (Set/3)	37-4010
DISSCR-VK10	10 Mesh Stainless Steel Screens for 6 Tube Assembly (Set/6)	37-2200
DISSCR03-VK10	10 Mesh Stainless Steel Screens for 3 Tube Assembly (Set/3)	QLA
GLA900-DB	900mL Clear Glass Disintegration Beaker, Flared Top	37-5200
GLA905-DB	900mL Clear Glass Disintegration Beaker, Flat Top	37-5305



DISASY-03



DISASY-06, DISASY-P6



DISTUB-03



DISTUB-06, DISTUB-P6



GLA900-DB



GLA905-DB



FDISC-VK

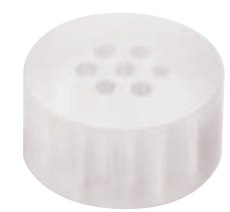

DISDISK-03



QLA Superior Quality Control

All manufacturing is performed on-site by experienced machinists where we manufacture under strict ISO 9001 standards and have 100% control over product quality.



QLA Main Office: Telford, PA
Tel 908-685-7500, Fax 908-526-4151, Toll Free: 855-QLA-LABS (855-752-5227)

YOUR DISSOLUTION SPECIALISTS



QUALITY LAB ACCESSORIES

www.QLA-LLC.com